

# BR-6428nS V3 BR-6228nS V3

## User Manual

08-2014 / v1.0

### **Edimax Technology Co., Ltd.**

No.3, Wu-Chuan 3rd Road, Wu-Gu, New Taipei City 24891, Taiwan

Email: [support@edimax.com.tw](mailto:support@edimax.com.tw)

---

### **Edimax Technology Europe B.V.**

Fijenhof 2, 5652 AE Eindhoven, The Netherlands

Email: [support@edimax.nl](mailto:support@edimax.nl)

---

### **Edimax Computer Company**

3350 Scott Blvd., Bldg.15 Santa Clara, CA 95054, USA

Live Tech Support: 1(800) 652-6776

Email: [support@edimax.com](mailto:support@edimax.com)

# CONTENTS

<b>I. Product Information.....</b>	<b>1</b>
I-1. Package Contents .....	1
I-2. LED Status .....	2
I-3. Back Panel.....	3
I-4. Safety Information.....	4
<b>II. Installation.....</b>	<b>5</b>
II-1. Wi-Fi Router Mode .....	8
II-2. Access Point Mode.....	12
II-3. Range Extender Mode .....	16
II-4. Wireless Bridge Mode.....	22
II-5. WISP Mode .....	28
II-6. WPS Setup.....	36
II-7. Reset to Factory Default Settings .....	36
<b>III. Browser Based Configuration Interface.....</b>	<b>37</b>
III-1. Login.....	37
III-2. Save Settings.....	39
III-3. Main Menu .....	40
III-3-1. Status .....	41
III-3-2. Setup Wizard.....	42
III-3-3. Internet/WISP .....	44
III-3-3-1. WAN Setup.....	45
III-3-3-1-1. Dynamic IP .....	45
III-3-3-1-2. Static IP .....	46
III-3-3-1-3. PPPoE .....	48
III-3-3-1-4. PPTP .....	50
III-3-3-1-5. L2TP.....	52
III-3-3-1-6. WISP.....	54
III-3-3-2. DDNS.....	55
III-3-4. LAN.....	57
III-3-5. 2.4GHz Wireless.....	60
III-3-5-1. Basic .....	60
III-3-5-1-1. Disable .....	64
III-3-5-1-2. WEP.....	65
III-3-5-1-3. WPA Pre-Shared Key.....	66
III-3-5-1-4. WPA Radius.....	67
III-3-5-2. Guest/ Multiple SSID.....	68
III-3-5-3. WPS.....	71

III-3-5-4.	Access Control .....	72
III-3-5-5.	Schedule.....	74
III-3-6.	Firewall.....	76
III-3-6-1.	URL Blocking .....	76
III-3-6-2.	Access Control .....	78
III-3-6-3.	DMZ.....	82
III-3-6-4.	DoS.....	83
III-3-7.	QoS.....	85
III-3-7-1.	QoS.....	85
III-3-7-2.	iQoS.....	88
III-3-8.	Advanced .....	90
III-3-8-1.	Static Routing.....	90
III-3-8-2.	Port Forwarding .....	91
III-3-8-3.	Virtual Server .....	93
III-3-8-4.	2.4GHz Wireless .....	94
III-3-8-5.	IGMP .....	96
III-3-8-6.	UPnP.....	97
III-3-9.	Administration .....	98
III-3-9-1.	Time Zone .....	98
III-3-9-2.	Password.....	99
III-3-9-3.	Remote Access.....	100
III-3-9-4.	Backup/Restore .....	101
III-3-9-5.	Upgrade .....	101
III-3-9-6.	Restart.....	102
III-3-9-7.	Logs .....	102
III-3-9-8.	Active DHCP Client.....	103
III-3-9-9.	Statistics.....	103

## **IV. Appendix ..... 104**

IV-1.	Configuring your IP address.....	104
IV-1-1.	How to check that your computer uses a dynamic IP address .....	105
IV-1-1-1.	Windows XP .....	105
IV-1-1-2.	Windows Vista .....	107
IV-1-1-3.	Windows 7 .....	109
IV-1-1-4.	Windows 8 .....	112
IV-1-1-5.	Mac OS.....	116
IV-1-2.	How to modify the IP address of your computer .....	118
IV-1-2-1.	Windows XP .....	118
IV-1-2-2.	Windows Vista .....	120
IV-1-2-3.	Windows 7 .....	121
IV-1-2-4.	Windows 8 .....	124
IV-1-2-5.	Mac .....	128

IV-1-3.	How to Find Your Network Security Key .....	131
IV-1-3-1.	Windows 7 & Vista.....	131
IV-1-3-2.	Mac .....	133
IV-1-4.	How to Find Your Router's IP Address.....	136
IV-1-4-1.	Windows XP, Vista & 7.....	136
IV-1-4-2.	Windows 8 .....	138
IV-1-4-3.	Mac .....	141
IV-2.	Connecting to a Wi-Fi network.....	143
IV-3.	Troubleshooting.....	145
IV-4.	Glossary.....	149

# ***I. Product Information***

---

## **I-1. Package Contents**

Before you start using this product, please check if there is anything missing in the package, and contact your dealer to claim the missing item(s):



***BR-6428nS V3***

*or*



***BR-6228nS V3***

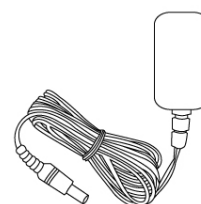

***Power Adapter***

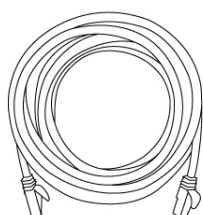

***Ethernet Cable***







***Quick Installation Guide***

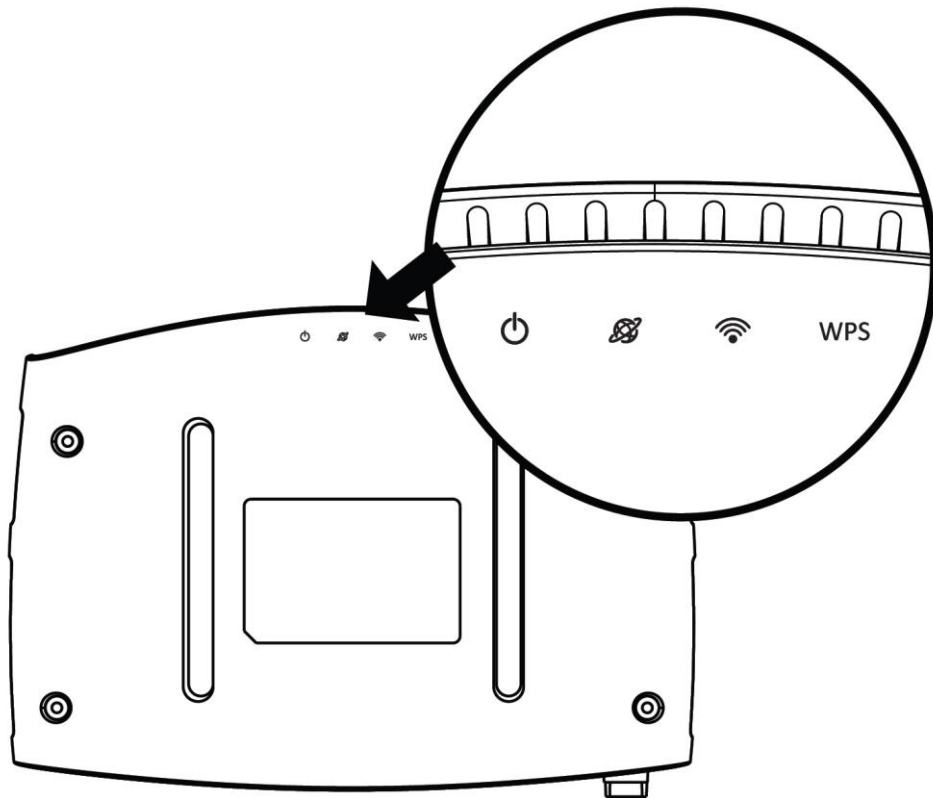

***CD-ROM***

## I-2. LED Status



LED	Color	LED Status	Description
Power 	White	On	Device is on.
		Off	Device is off.
Internet 	Blue	On	Internet is connected.
		Flashing	No Internet connection.
Wi-Fi 	Blue	On	Wi-Fi activity (transferring/receiving data).
		Off	Wi-Fi not active.
WPS  WPS	Blue	On	WPS connection established (displays on for one minute).
		Flashing	WPS in progress.
		Off	No WPS connection.

### I-3. Back Panel

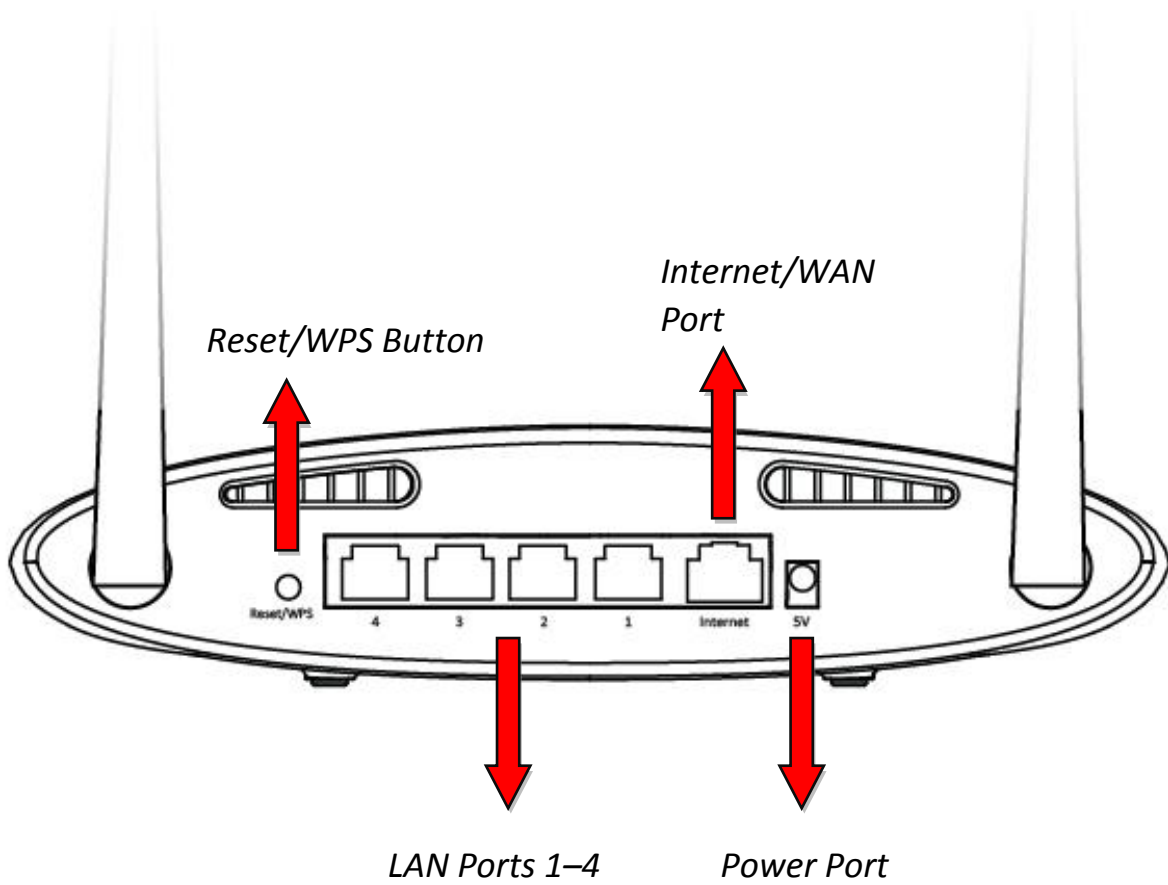

## **I-4. Safety Information**

In order to ensure the safe operation of the device and its users, please read and act in accordance with the following safety instructions.

1. The device is designed for indoor use only; do not place it outdoors.
2. Do not place the device in or near hot/humid places, such as a kitchen or bathroom.
3. Do not pull any connected cable with force; carefully disconnect it from the BR-6428nS V3/BR-6228nS V3.
4. Handle the device with care. Accidental damage will void the warranty of the device.
5. The device contains small parts which are a danger to small children under 3 years old. Please keep the device out of reach of children.
6. Do not place the device on paper, cloth, or other flammable materials. The device may become hot during use.
7. There are no user-serviceable parts inside the device. If you experience problems with the device, please contact your dealer of purchase and ask for help.
8. The device is an electrical device and as such, if it becomes wet for any reason, do not attempt to touch it without switching the power supply off. Contact an experienced electrical technician for further help.



## II. Installation

---

1. Plug the included power adapter into the device's 5V DC power port and the other end into an electrical socket.

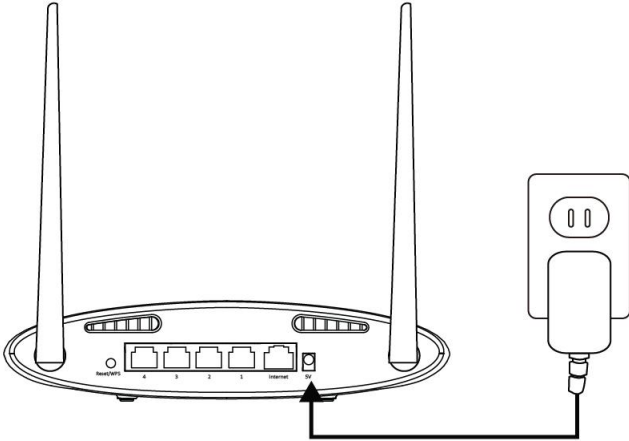

2. Ensure that the power LED is lit. If not, the device is not properly connected.

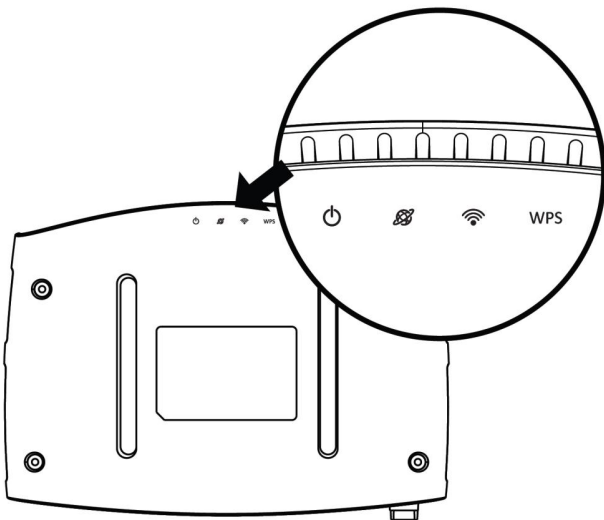

3. Use a Wi-Fi device (e.g. computer, tablet, smartphone) to search for a Wi-Fi network with the SSID “edimax.setup” and connect to it.

 ***iOS 4 or Android 4 and above are required for setup on a smartphone or tablet.***

4. Open a web browser and if you do not automatically arrive at the “Get Started” screen shown below, enter the URL ***http://edimax.setup*** and click “**Get Started**” to begin the setup process.



 **If you cannot access <http://edimax.setup>, please make sure your computer is set to use a dynamic IP address. Refer to [IV-1. Configuring your IP address](#) for more information.**

5. Choose if you want to use your product in its default Wi-Fi router mode or in a different mode.



The device's five available modes are outlined below:

<b>Wi-Fi Router Mode</b>	<i>The device connects to your <b>modem</b> and provides 2.4GHz Internet (wireless and Ethernet) access for your network devices.</i>
<b>Access Point Mode</b>	<i>The device connects to an existing <b>router</b> via Ethernet cable and provides 2.4GHz Internet (wireless and Ethernet) access for your network devices.</i>
<b>Range Extender Mode</b>	<i>The device connects wirelessly to your existing 2.4GHz network and repeats the wireless signal(s).</i>
<b>Wireless Bridge Mode</b>	<i>The device connects to a network device for example: TV, gaming console, or media player via Ethernet cable and acts as a wireless receiver, allowing the network device to join your Wi-Fi network.</i>
<b>WISP Mode</b>	<i>The device connects wirelessly to your Wireless Internet Service Provider and provides 2.4GHz Internet (wireless and Ethernet) access for your network devices.</i>

## II-1. Wi-Fi Router Mode

1. Select whether to use the iQ Setup wizard (recommended) to detect your Internet connection type, or enter the settings manually.

 **Manual configuration is only recommended for advanced users.**

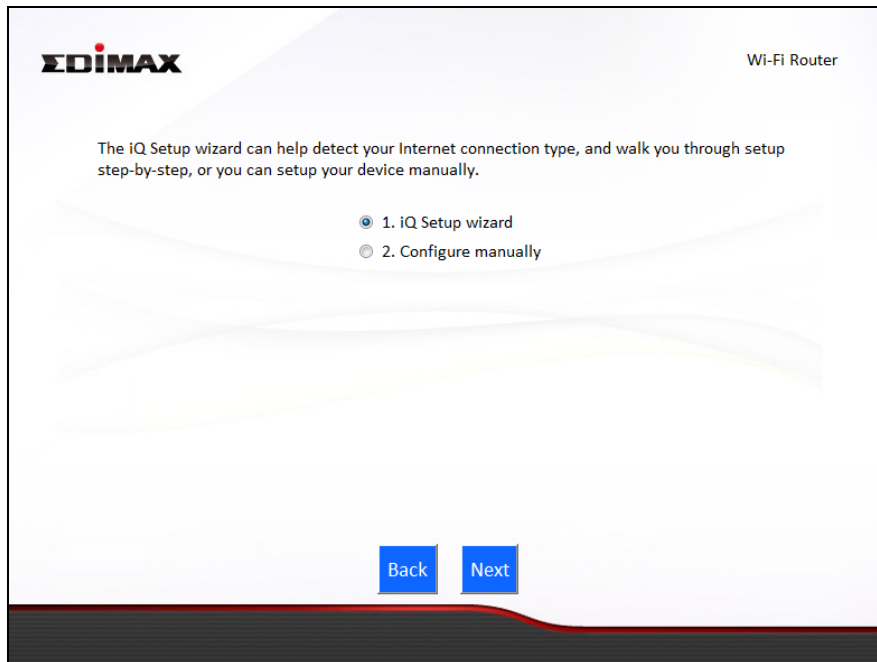

2. Connect the Internet port of your device to the LAN port of your modem using an Ethernet cable, and then click "Next".

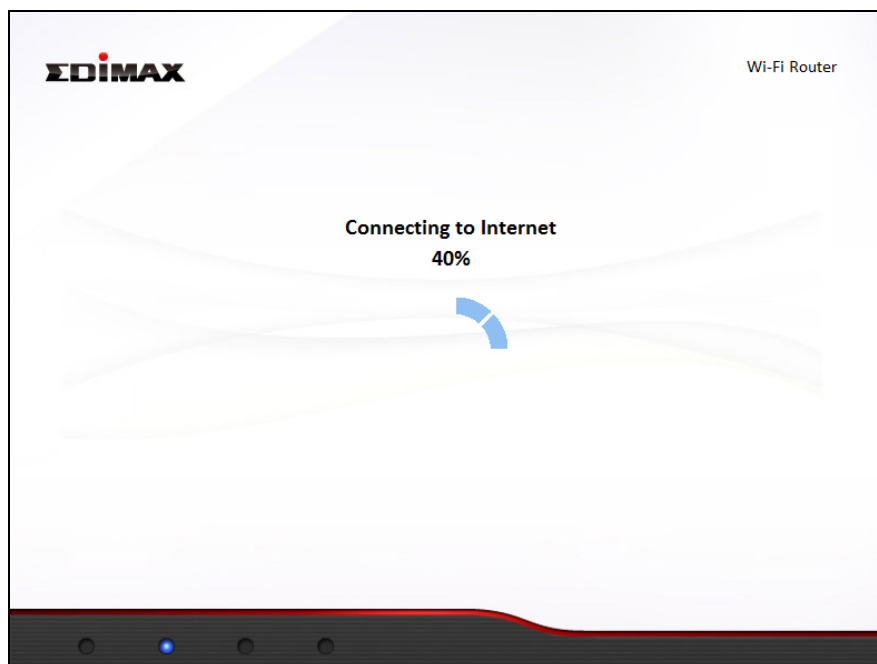

**3.** Please wait a moment while the device tests the connection.

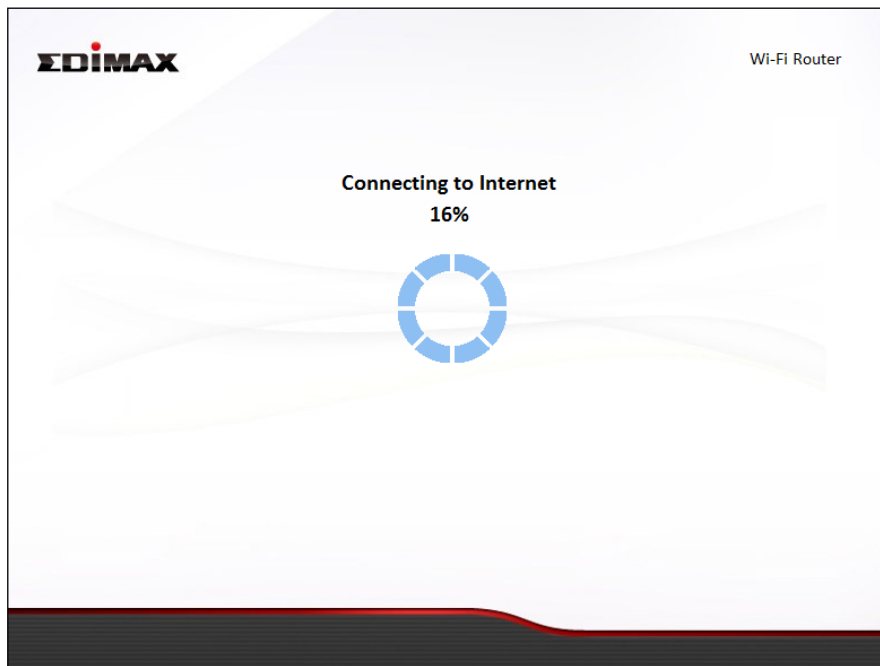

**4.** Click “Next” to continue and configure the device’s wireless network.

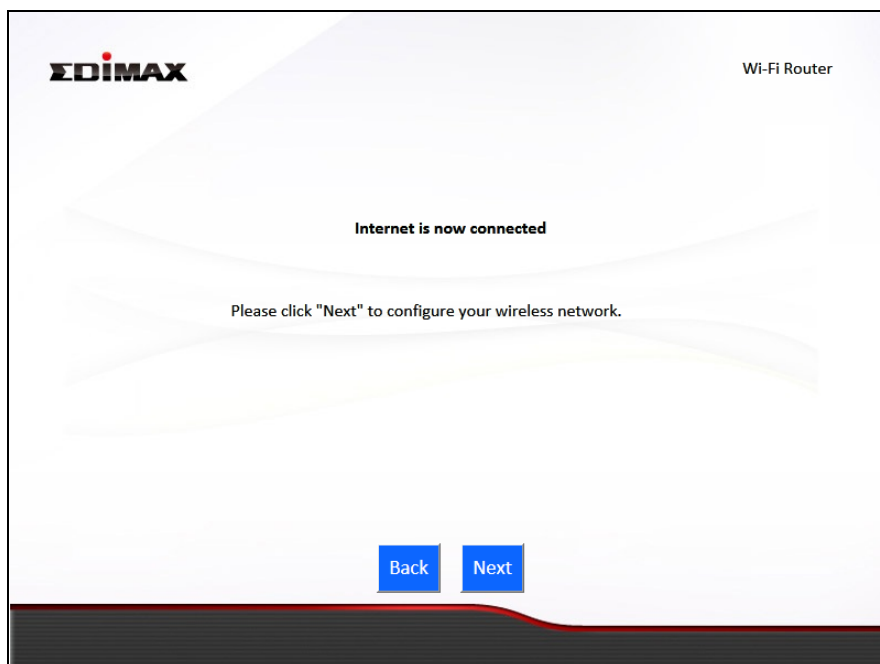

**5.** Enter a name and password for your 2.4GHz wireless network, then click “Next” to continue.

- 6.** A summary of your configuration will be displayed, as shown below depending on your Internet type. Check that all of the details are correct and then click “Next” to proceed.



***If you wish to backup the device’s settings, click “Backup this configuration” to open a new window and save your current configuration to a .txt file.***

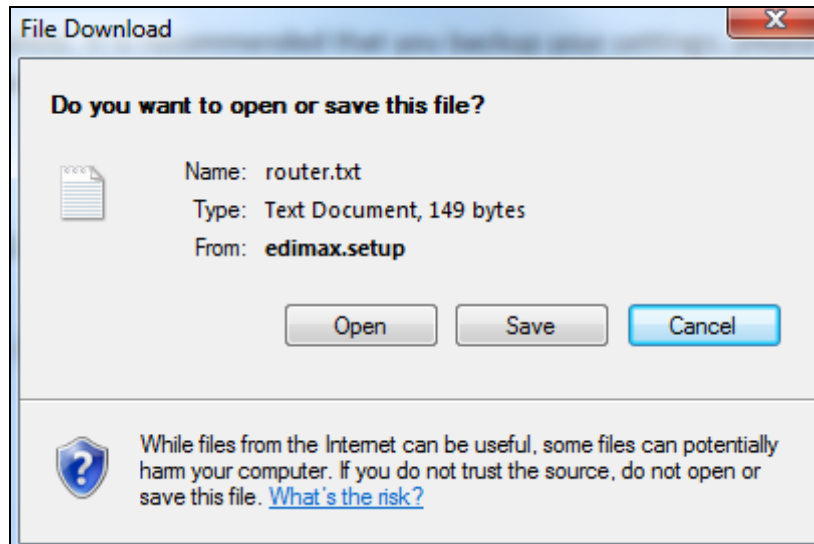

**7.** Please wait while the device applies your settings.

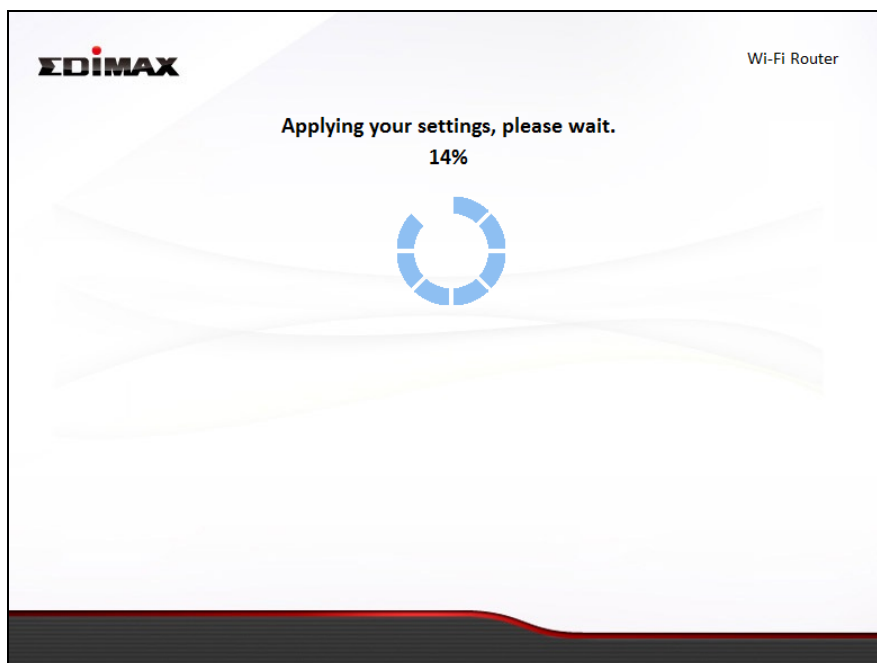

**8.** A final congratulations screen will indicate that setup is complete. You can now connect to the device's new SSID(s) which are shown on the screen then close the browser window.

## II-2. Access Point Mode

1. Select “Access Point” from the top menu and click “Next”.

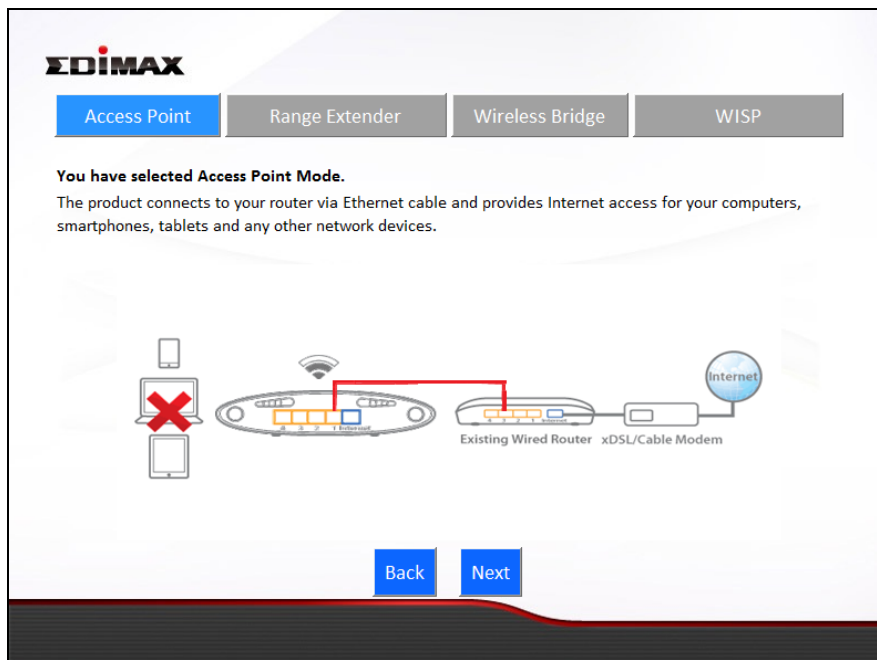

2. Connect the LAN port of your BR-6428nS V3/BR-6228nS V3 to the LAN port of your existing router using an Ethernet cable, then click “Next”.

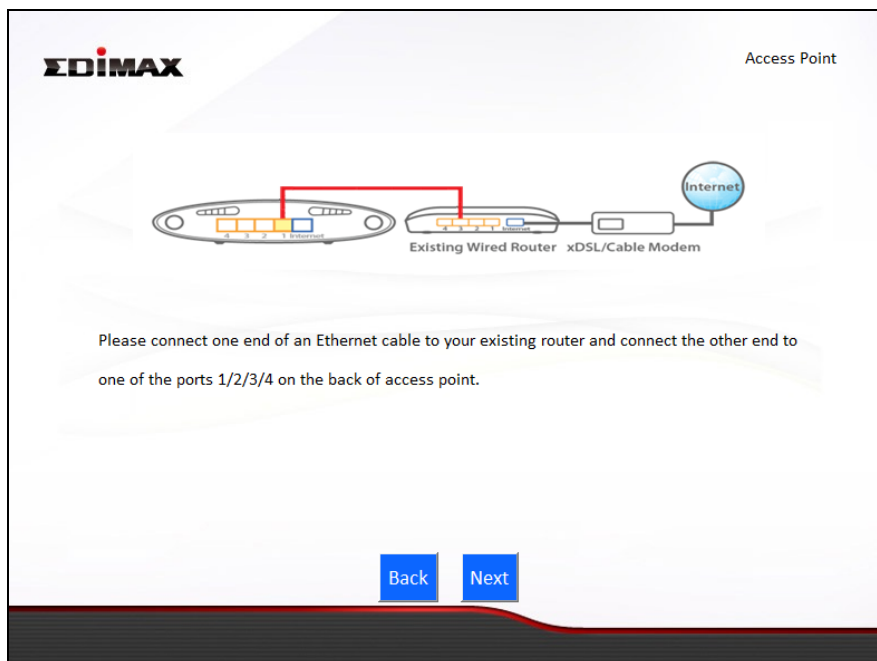

3. Select “Obtain an IP address automatically” or “Use the following IP address” for your BR-6428nS V3/BR-6228nS V3. If you are using a static IP, enter the IP address, subnet mask and default gateway. Click “Next” to proceed to the next step.



The screenshot shows the EDIMAX Access Point configuration interface. At the top left is the EDIMAX logo, and at the top right is the text "Access Point". The main heading is "Please set the IP address of the access point." Below this, there are two radio button options: "Obtain an IP address automatically" (which is selected) and "Use the following IP address". Under the second option, there are three rows of input fields: "IP address" with values 192, 168, 2, 3; "Subnet Mask" with values 255, 255, 255, 0; and "Default gateway" with values 0, 0, 0, 0. At the bottom of the form are two blue buttons labeled "Back" and "Next".





***“Obtain an IP address automatically” is the recommended setting for most users. For more guidance on static IP addresses, please refer to [IV-1. Configuring your IP address.](#)***

4. Enter a name and password for your 2.4GHz wireless network, then click “Next” to continue.

The screenshot shows the EDIMAX Access Point configuration interface for Wi-Fi settings. At the top left is the EDIMAX logo, and at the top right is the text "Access Point". The main heading is "Please set your Wi-Fi network name (SSID) and Wi-Fi password." Below this, there are two input fields: "Wi-Fi network name (2.4GHz):" with the value "edimax\_2.4G\_8196D1" and "Wi-Fi password (WPA2-AES):" with the value "abcd1234". Below the password field is the text "(at least 8 characters)". At the bottom of the form are two blue buttons labeled "Back" and "Next".

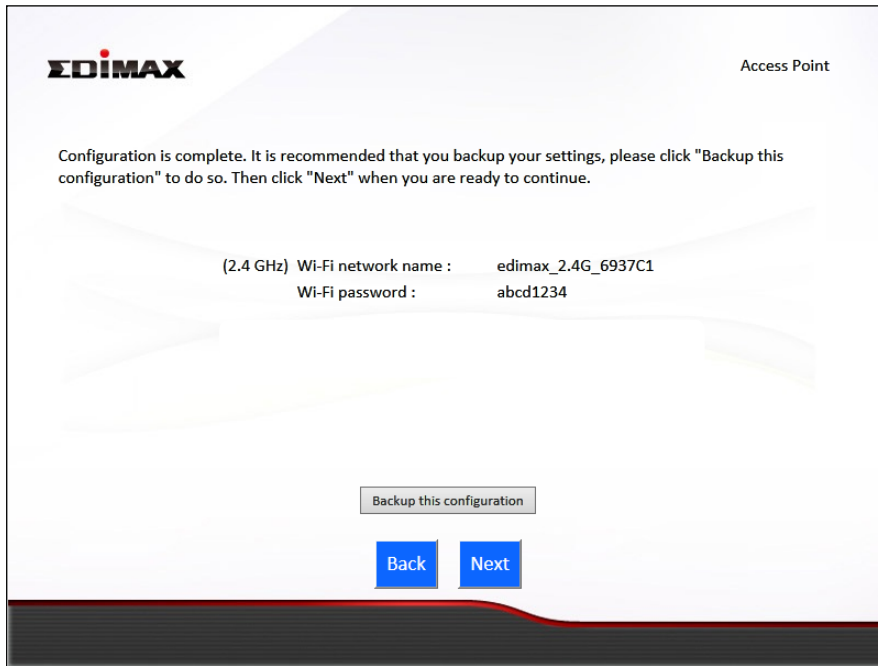
5. A summary of your configuration will be displayed, as shown below. Check that all of the details are correct and then click “Next” to proceed.



 ***If you wish to backup the device's settings, click "Backup this configuration" to open a new window and save your current configuration to a .txt file.***

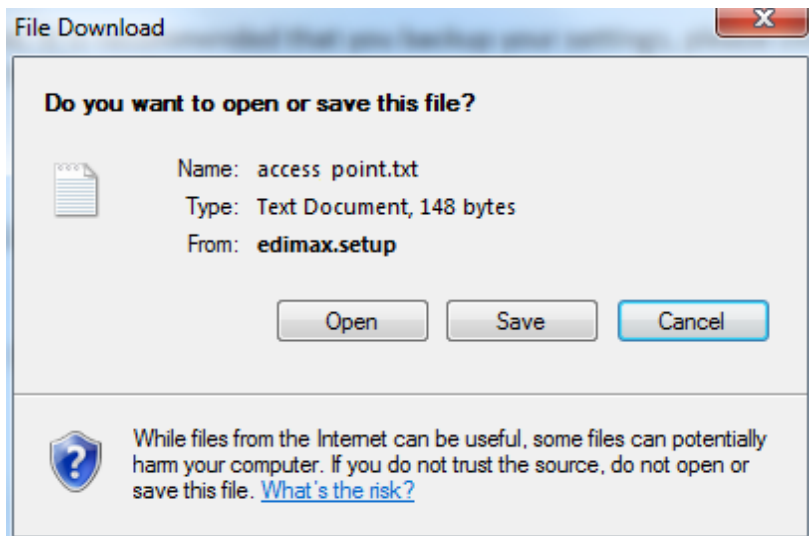

**6.** Please wait a moment until the BR-6428nS V3/BR-6228nS V3 is ready.

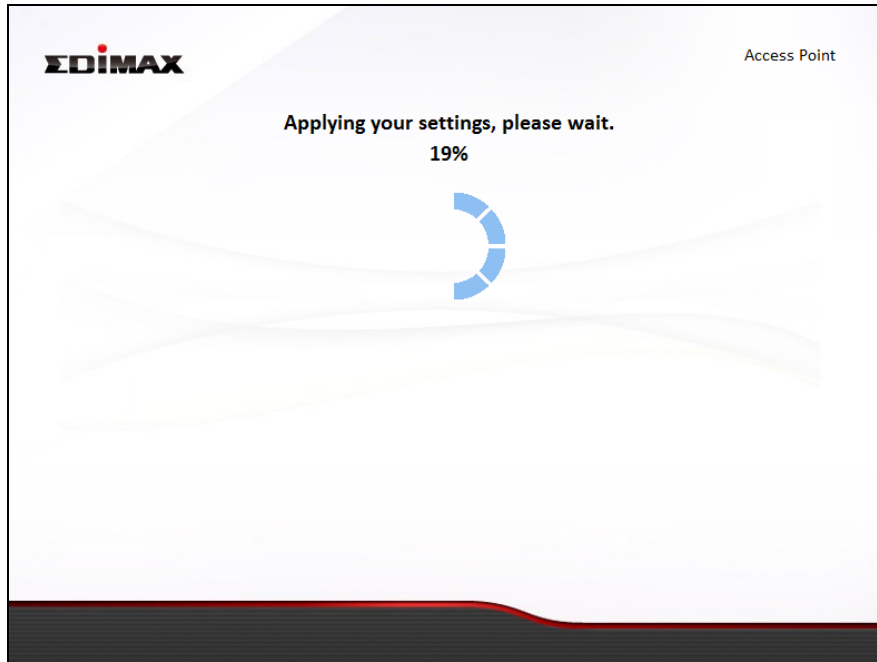

8. A final congratulations screen will indicate that setup is complete. You can now connect to the device's new SSID(s) which are shown on the screen then close the browser window.

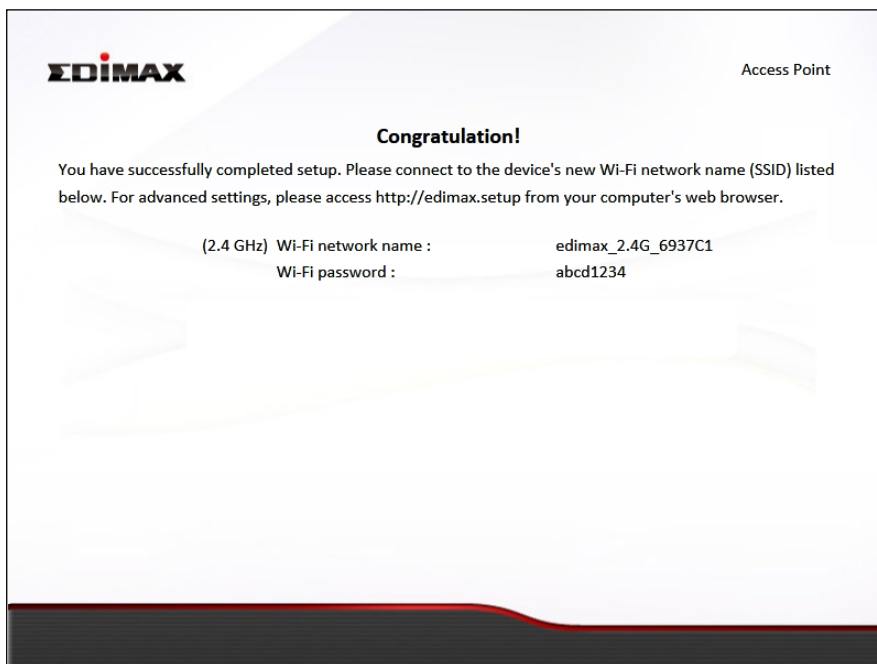

9. The BR-6428nS V3/BR-6228nS V3 is working and ready for use. Refer to [IV-2. Connecting to a Wi-Fi network](#) if you require more guidance.

## II-3. Range Extender Mode

1. Select “Range Extender” from the top menu and click “Next”.

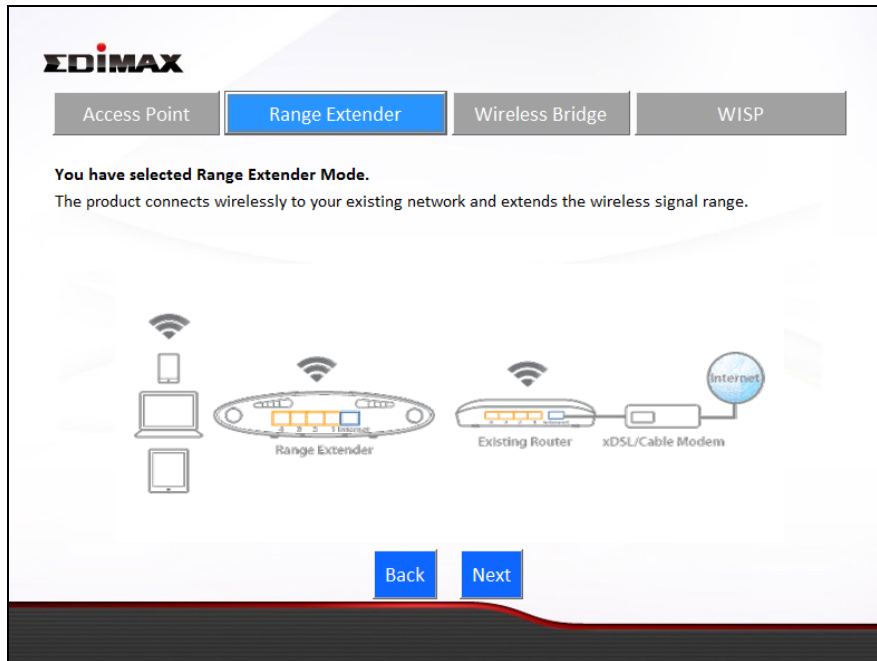

2. Please ensure your BR-6428nS V3/BR-6228nS V3 is within Wi-Fi range of your existing wireless router. Click “Next” to continue.

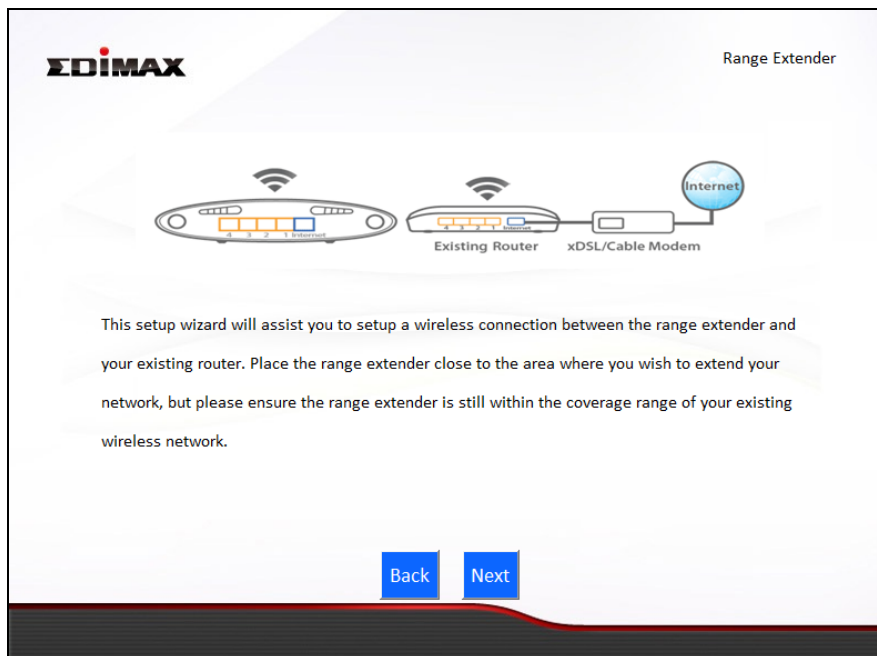

3. Select the Wi-Fi network name (SSID) which you wish to connect to for the specified frequency and click “Next” to continue.



***If the Wi-Fi network you wish to connect to does not appear, try clicking “Refresh”.***

**EDIMAX** Range Extender

### 2.4GHz Wireless Site Survey

The range extender is surveying all available routers nearby. Please select the router you wish to connect to. If the router you wish to connect is not listed, try clicking "Refresh". To connect to a hidden SSID please select "Setup extender manually".

Setup extender manually

Select	SSID	Signal
<input type="radio"/>	WAP1750-E6D4C0_G_2	100%
<input type="radio"/>	WAP1750_G	100%
<input type="radio"/>	MIS-Jacky	100%
<input type="radio"/>	EdimaxHQ	100%
<input type="radio"/>	OBM-Dlink817_2.4G	100%
<input type="radio"/>	TOTOLINK N300R+	100%

Back Refresh Next



**To connect to a hidden SSID, check the “Setup extender manually” box and enter the details manually on the next page, as shown below.**

**EDIMAX** Range Extender

### 2.4GHz Wireless Site Survey

Please set a new Wi-Fi network name (SSID) for the range extender if you wish, and set the security key for your existing wireless network if required.

Wi-Fi network name (SSID):

Range extender SSID:

Encryption:

Security Type:  TKIP  AES

Key Format:

Wi-Fi password (Security Key):

Back Next

4. Enter your existing wireless network’s security key/password in the “Security Key” field and click “Next” to continue.

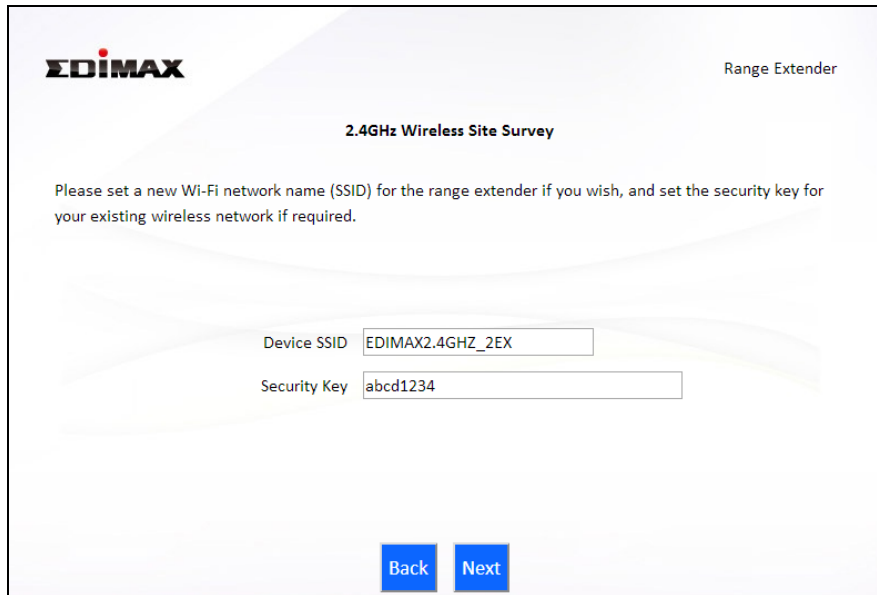

The image shows the EDIMAX Range Extender configuration interface. At the top left is the EDIMAX logo, and at the top right is the text "Range Extender". The main heading is "2.4GHz Wireless Site Survey". Below this, a message reads: "Please set a new Wi-Fi network name (SSID) for the range extender if you wish, and set the security key for your existing wireless network if required." There are two input fields: "Device SSID" with the value "EDIMAX2.4GHZ\_2EX" and "Security Key" with the value "abcd1234". At the bottom, there are two blue buttons labeled "Back" and "Next".

5. Wait a moment while the BR-6428nS V3/BR-6228nS V3 tests the wireless connection.

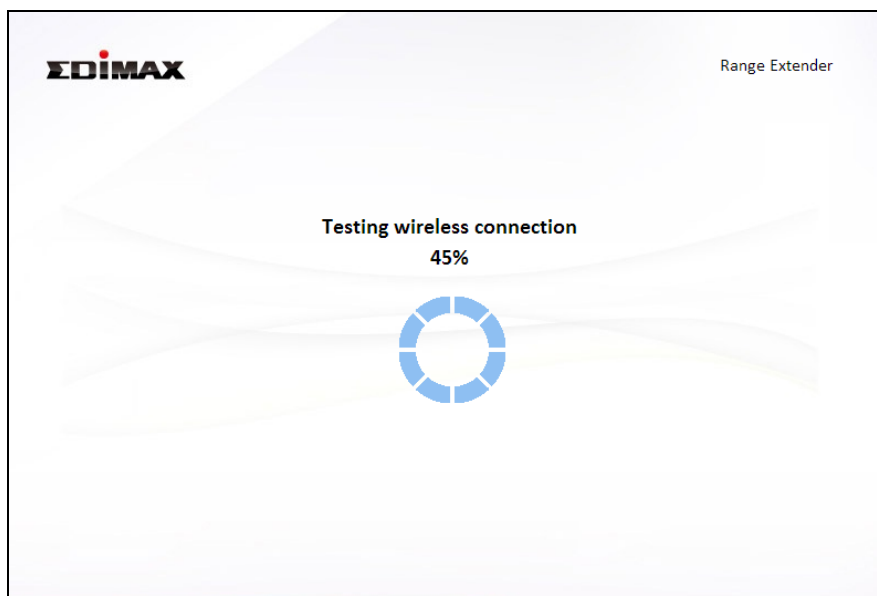

6. Select "Obtain an IP address automatically" or "Use the following IP address" for your BR-6428nS V3/BR-6228nS V3. If you are using a static IP, enter the IP address, subnet mask and default gateway. Click "Next" to proceed to the next step.

 ***"Obtain an IP address automatically" is the recommended setting for most users. The IP address will be displayed in brackets.***

**EDIMAX** Range Extender

Connection test complete. Please click "Next" when you are ready to continue.

Obtain an IP address automatically (IP : 10.0.20.136)  
 Use the following IP address

IP address :  .  .  .   
 Subnet Mask :  .  .  .   
 Default gateway :  .  .  .

[Back](#) [Next](#)

- 7.** A summary of your configuration will be displayed, as shown below. Check that all of the details are correct and then click “Next” to proceed.



***The device will use the same wireless password/security key as the existing wireless network.***

**EDIMAX** Range Extender

Configuration is complete. It is recommended that you backup your settings, please click "Backup this configuration" to do so. Then click "Next" when you are ready to continue.

IP address : 192.168.10.147  
 (2.4 GHz) Wi-Fi network name : EDIMAX2.4GHZ\_2EX  
 Wi-Fi password : abcd1234

[Backup this configuration](#)

[Back](#) [Next](#)



***If you wish to backup the BR-6428nS V3/BR-6228nS V3's settings, click “Backup this configuration” to open a new window and save your current configuration to a .txt file.***

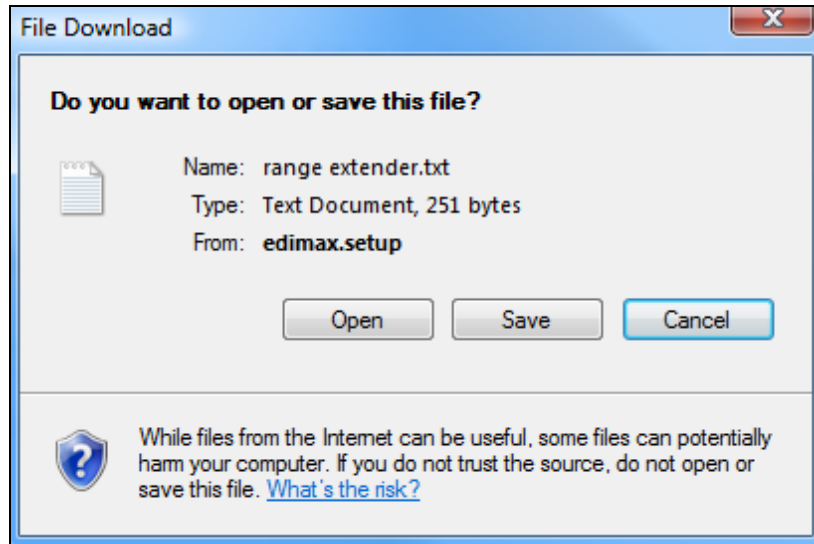

8. Please wait a moment until the BR-6428nS V3/BR-6228nS V3 is ready.

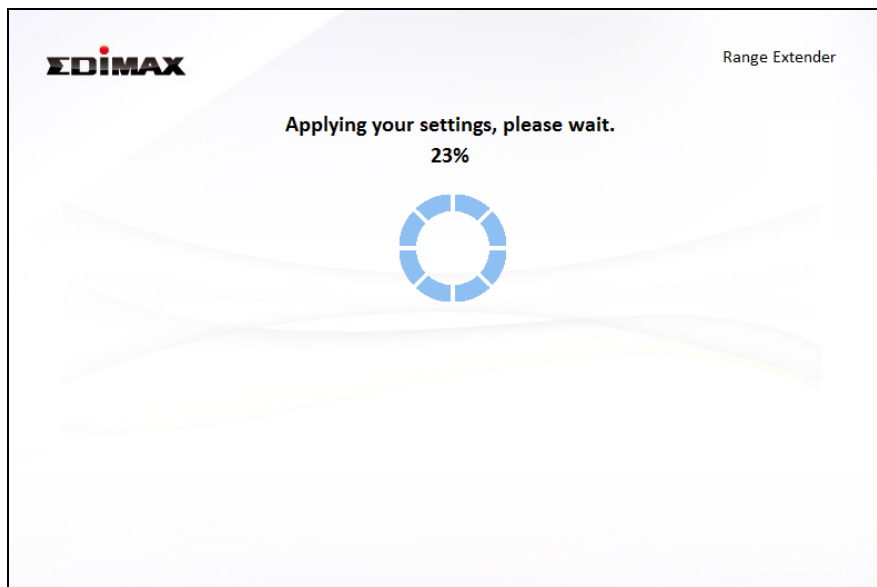

9. A final congratulations screen will indicate that setup is complete. You can now connect to the device's new SSID(s) which are shown on the screen then close the browser window.



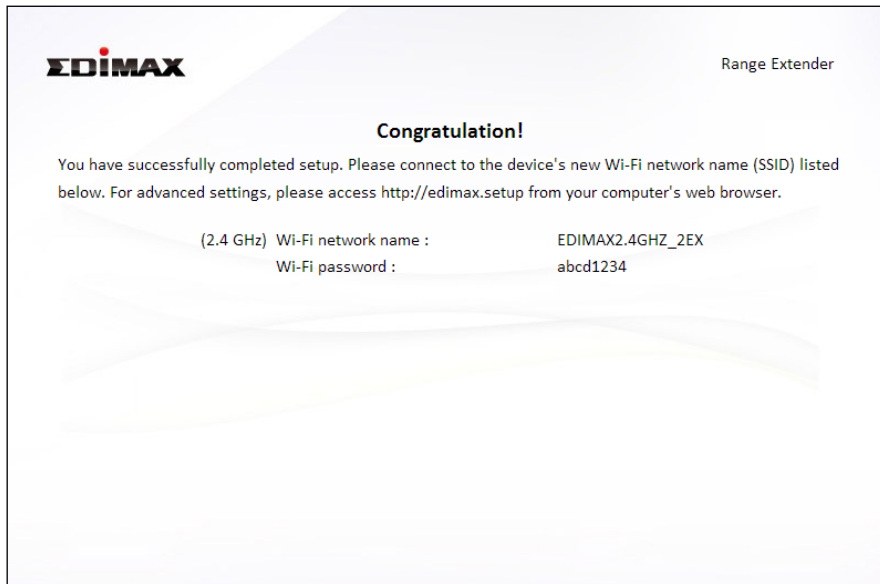

**10.** The BR-6428nS V3/BR-6228nS V3 is working and ready for use. Refer to [IV-2. Connecting to a Wi-Fi network](#) if you require more guidance.

## II-4. Wireless Bridge Mode

1. Select “Wireless Bridge” from the top menu and click “Next”.

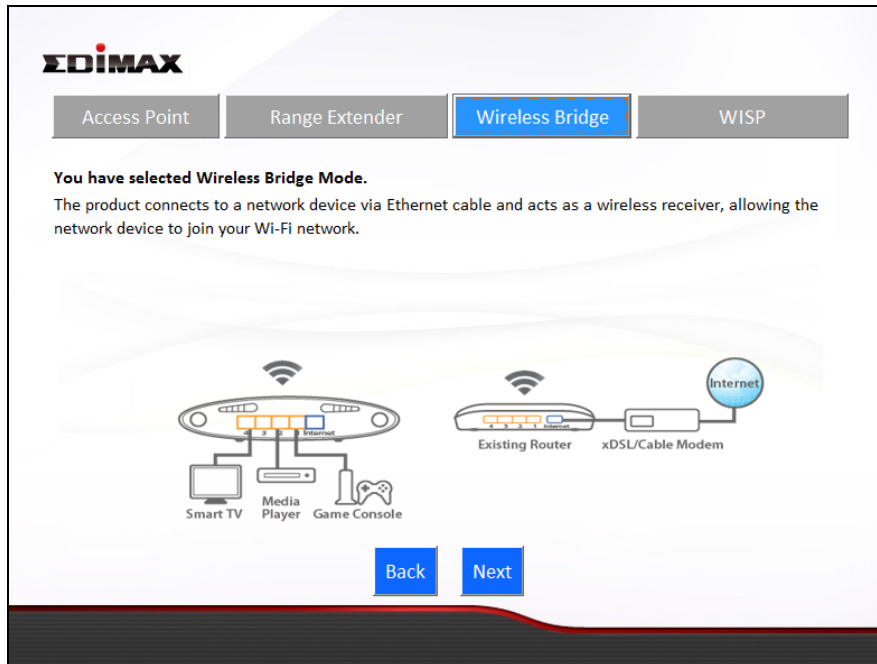

2. Please ensure your BR-6428nS V3/BR-6228nS V3 is within Wi-Fi range of your existing wireless router. Click “Next” to continue.

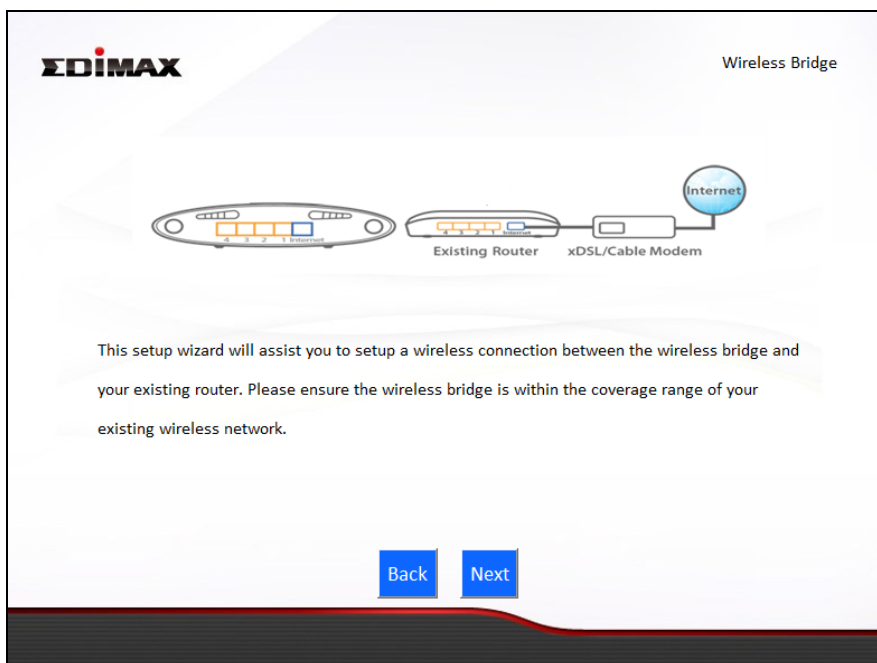

3. Select the Wi-Fi network name (SSID) which you wish to connect to and click “Next” to continue.



**If the Wi-Fi network you wish to connect to does not appear, try clicking “Refresh”.**

**EDIMAX** Wireless Bridge

### 2.4GHz Wireless Site Survey

The wireless bridge is surveying all available routers nearby. Please select the router you wish to connect to. If the router you wish to connect is not listed, try clicking "Refresh". To connect to a hidden SSID please select "Setup wireless bridge manually".

Setup wireless bridge manually.

Select	SSID	Signal
<input type="radio"/>	Matt	100%
<input type="radio"/>	FREE Wi-Fi	100%
<input type="radio"/>	OBM_68U	100%
<input type="radio"/>	OBM to LAN	100%
<input type="radio"/>	Edimax IP CAM_2.4G	100%



**To connect to a hidden SSID, check the “Setup extender manually” box and enter the details manually on the next page, as shown below.**

**EDIMAX** Wireless Bridge

### 2.4GHz Wireless Site Survey

Please enter your existing Wi-Fi network name (SSID) and security key if required.

Wi-Fi network name (SSID):

Encryption: WPA Pre-shared Key

WPA Type:  WPA(TKIP)  WPA2(AES)

Key Format: Passphrase

Wi-Fi password (Security Key):

- 4.** Enter your existing wireless network’s security key/password in the “Security Key” field and click “Next” to continue.

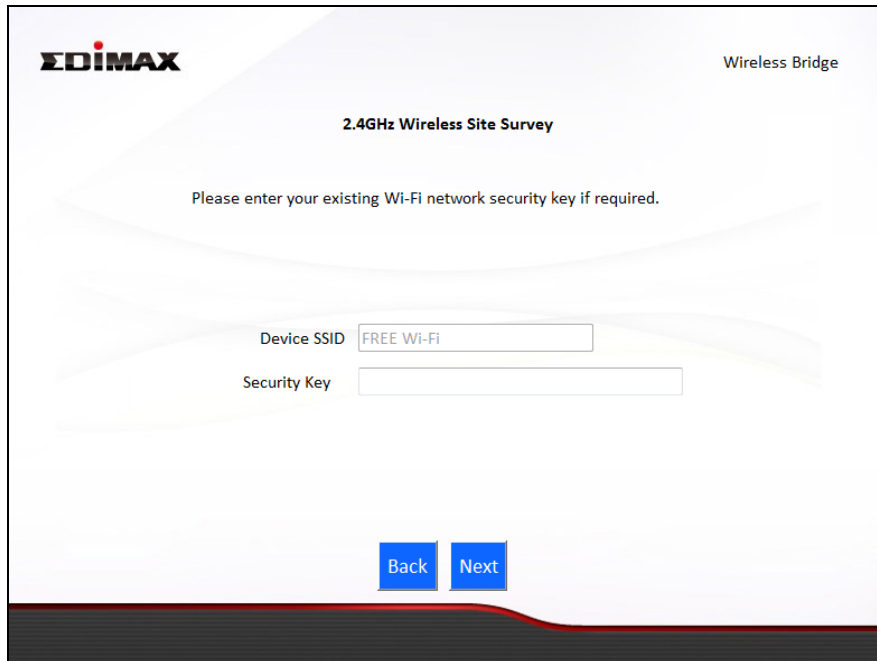

5. Wait a moment while the BR-6428nS V3/BR-6228nS V3 tests the wireless connection.

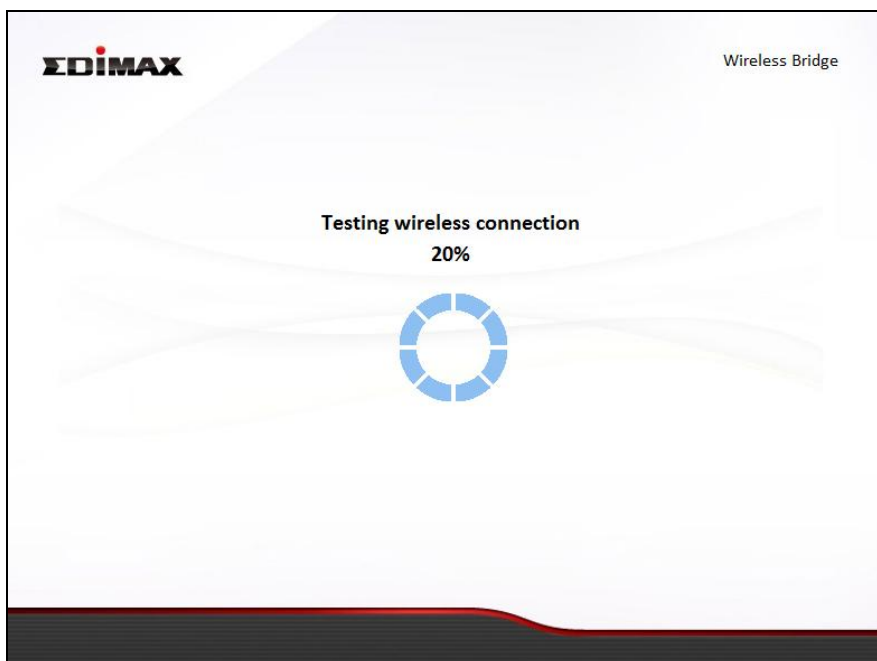

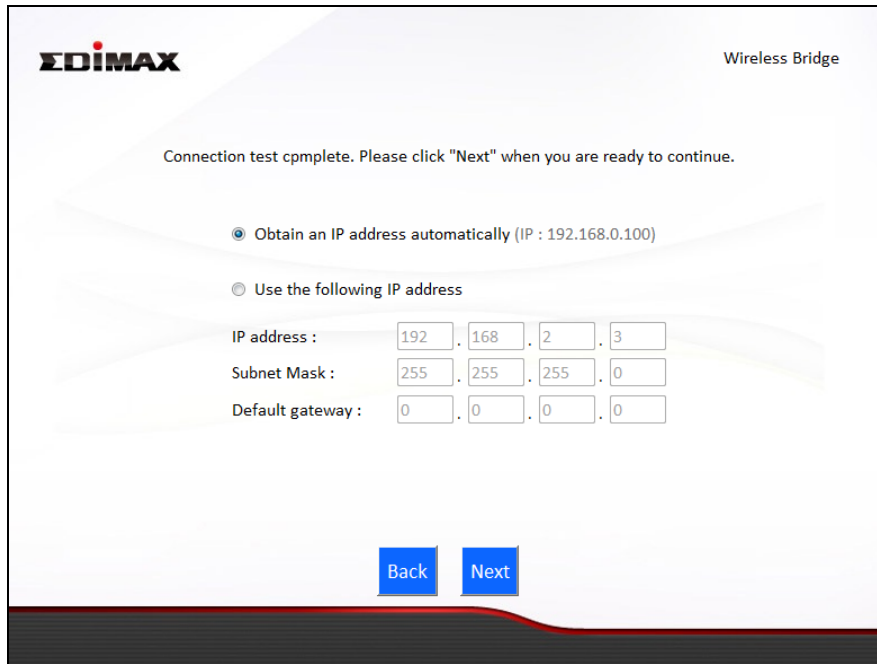

7. Select “Obtain an IP address automatically” or “Use the following IP address” for your BR-6428nS V3/BR-6228nS V3. If you are using a static IP, enter the IP address, subnet mask and default gateway. Click “Next” to proceed to the next step.

 ***“Obtain an IP address automatically” is the recommended setting for most users. The IP address will be displayed in brackets.***

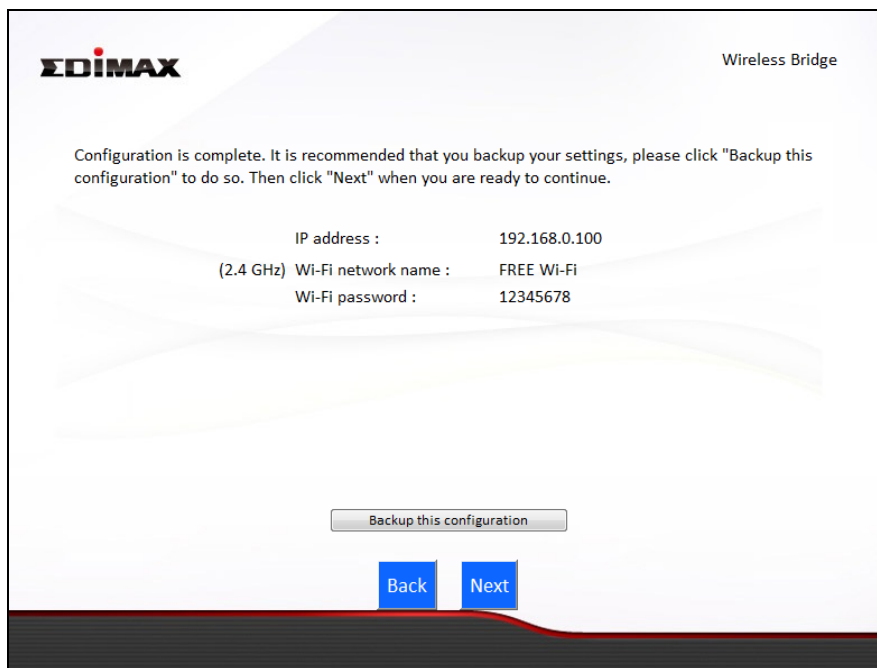

8. A summary of your configuration will be displayed, as shown below. Check that all of the details are correct and then click “Next” to proceed.



 ***If you wish to backup the BR-6428nS V3/BR-6228nS V3's settings, click “Backup this configuration” to open a new window and save your current configuration to a .txt file.***

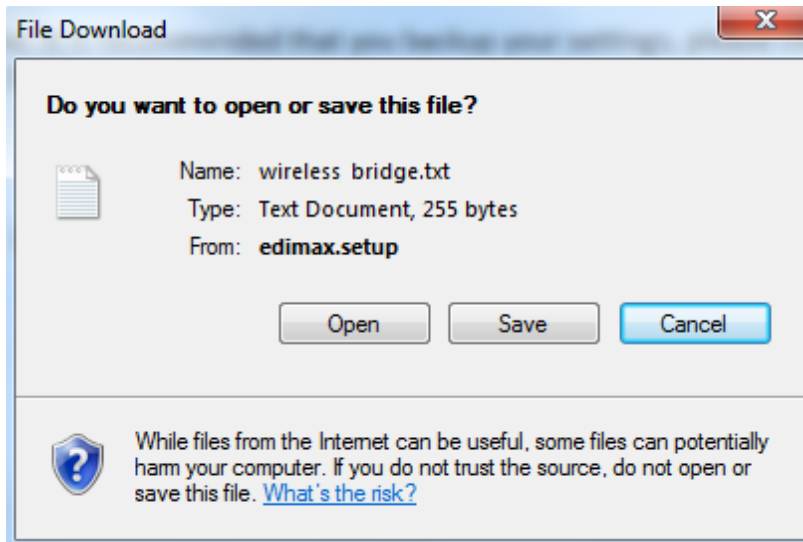

**9.** Please wait a moment until the BR-6428nS V3/BR-6228nS V3 is ready.

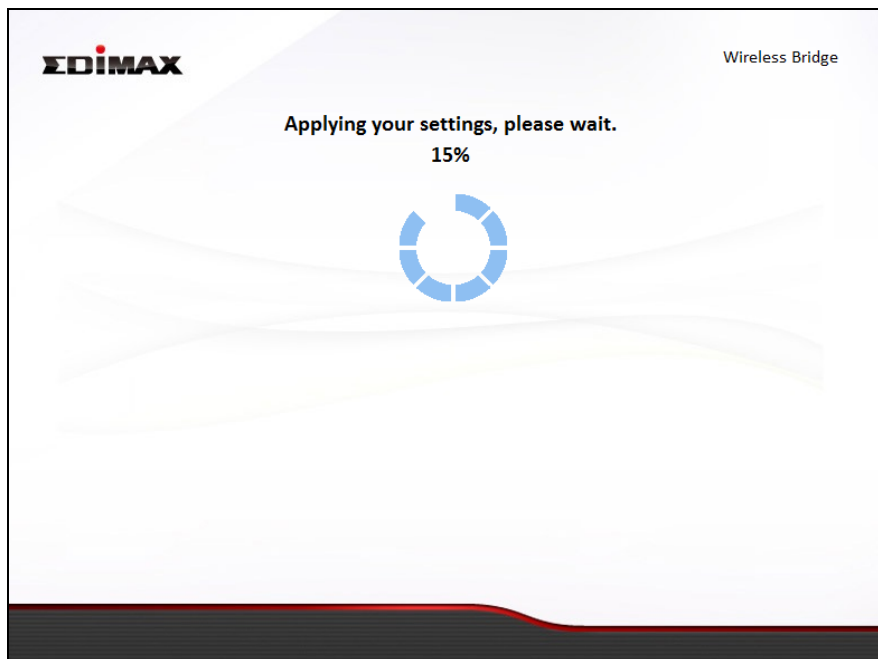

**10.** A final congratulations screen will indicate that setup is complete. Please close the browser window.

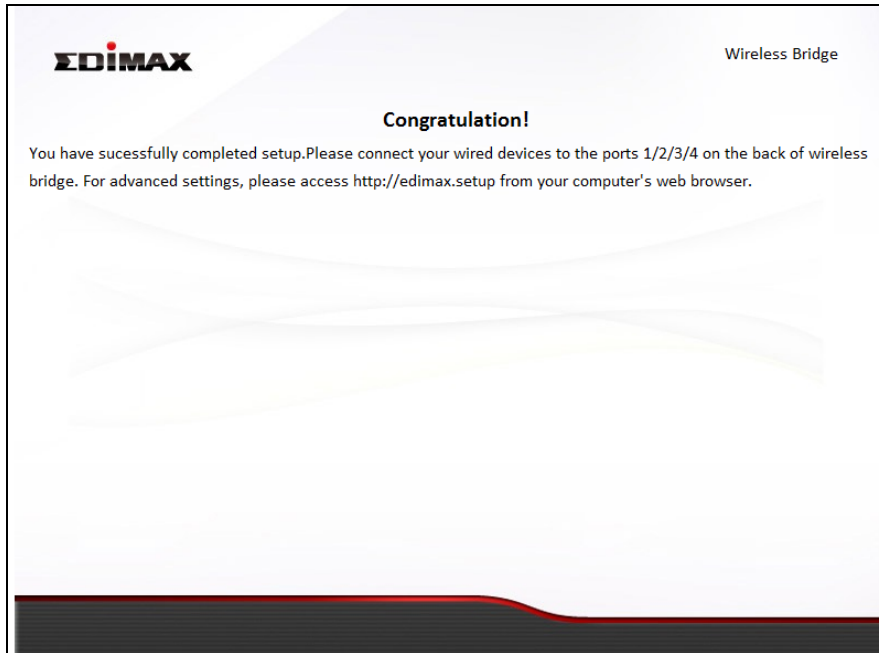

- 11.** The BR-6428nS V3/BR-6228nS V3 is working and ready for use. You can now connect the BR-6428nS V3/BR-6228nS V3 to your network device using an Ethernet cable and connect to your network as usual.

## II-5. WISP Mode

1. Select “WISP” from the top menu and click “Next”.

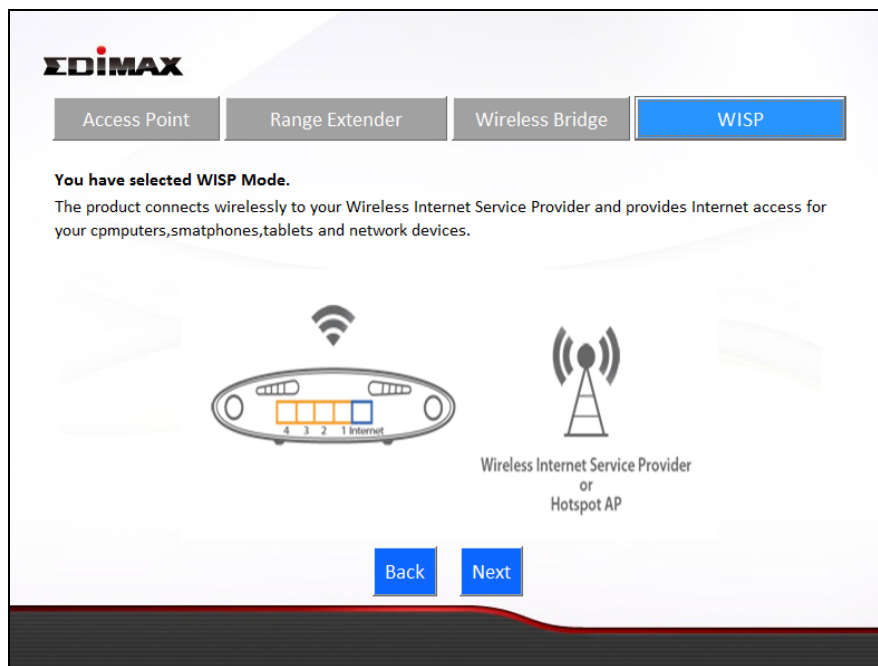

2. Please ensure your BR-6428nS V3/BR-6228nS V3 is within Wi-Fi range of your WISP network and click “Next” to continue.

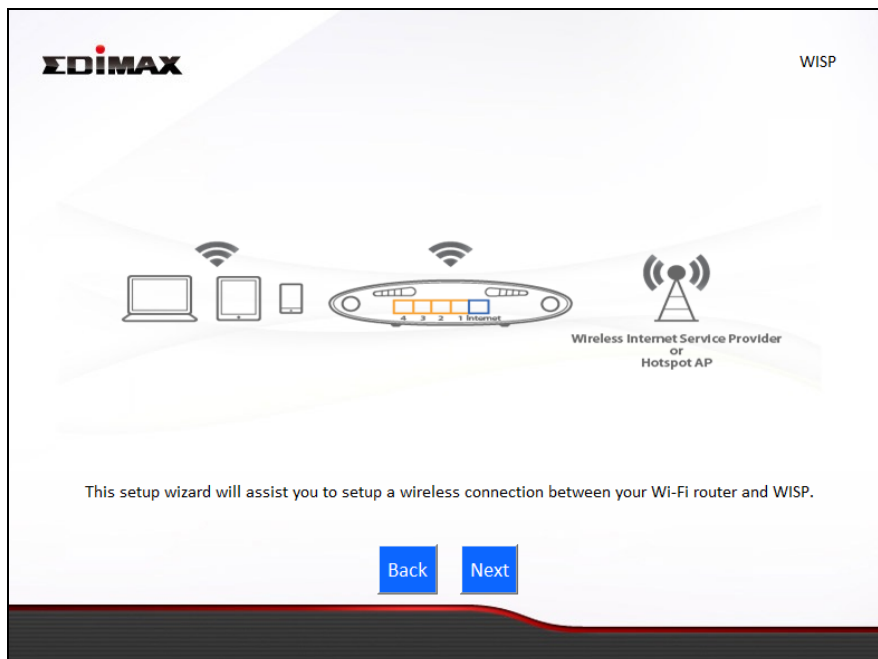

3. Select whether to use the iQ Setup wizard (recommended) to detect your Internet connection type, or enter the settings manually.





**Manual configuration is only recommended for advanced users.**

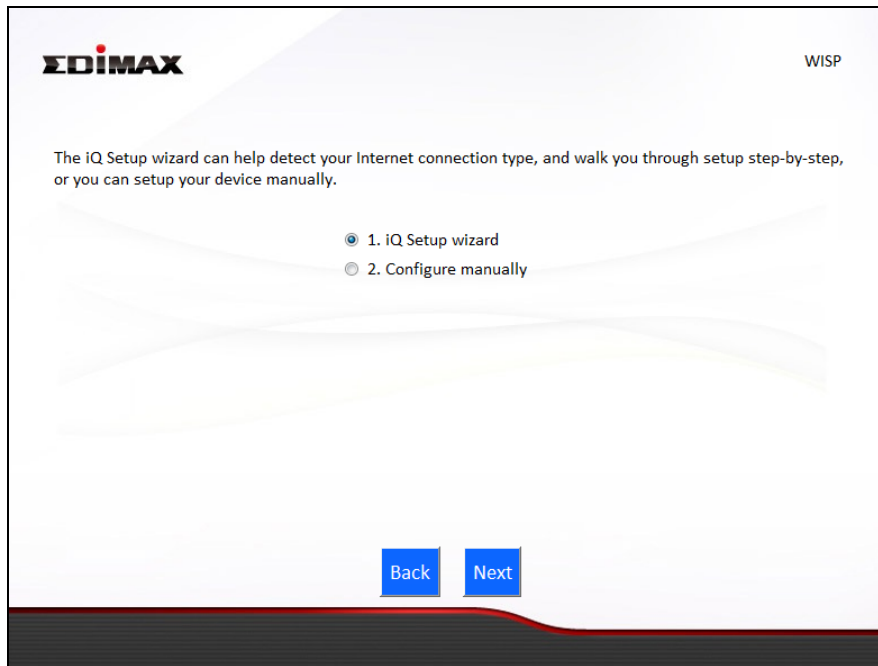

- 5.** Select the WISP SSID which you wish to connect to and click “Next” to continue.



**If the Wi-Fi network you wish to connect to does not appear, try clicking “Refresh”.**

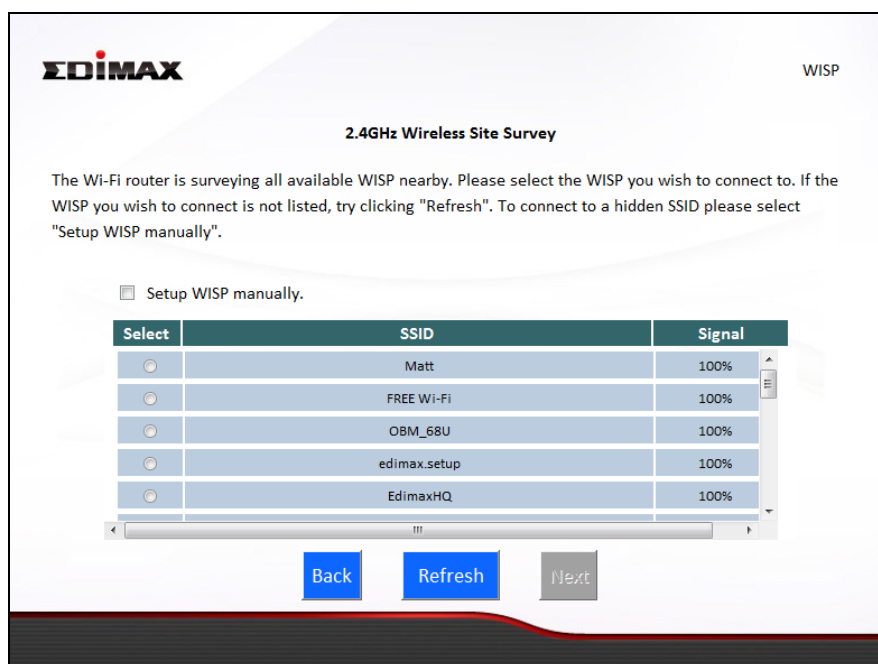



**To connect to a hidden SSID, check the “Setup extender manually” box and enter the details manually on the next page, as shown below.**

**EDIMAX** WISP

### 2.4GHz Wireless Site Survey

Please enter your WISP's Wi-Fi network name and the security key provide from your WISP if required.

Wi-Fi network name (SSID):

Encryption: WPA Pre-shared Key

WPA Type:  WPA(TKIP)  WPA2(AES)

Key Format: Passphrase

Wi-Fi password (Security Key):

[Back](#) [Next](#)

**6.** Enter your existing wireless network’s security key/password in the “Security Key” field and click “Next” to continue.

**EDIMAX** WISP

### 2.4GHz Wireless Site Survey

Please enter the security key provide from your WISP if required.

Device SSID: FREE Wi-Fi

Security Key:

[Back](#) [Next](#)

**7.** Wait a moment while the BR-6428nS V3/BR-6228nS V3 tests the wireless connection.

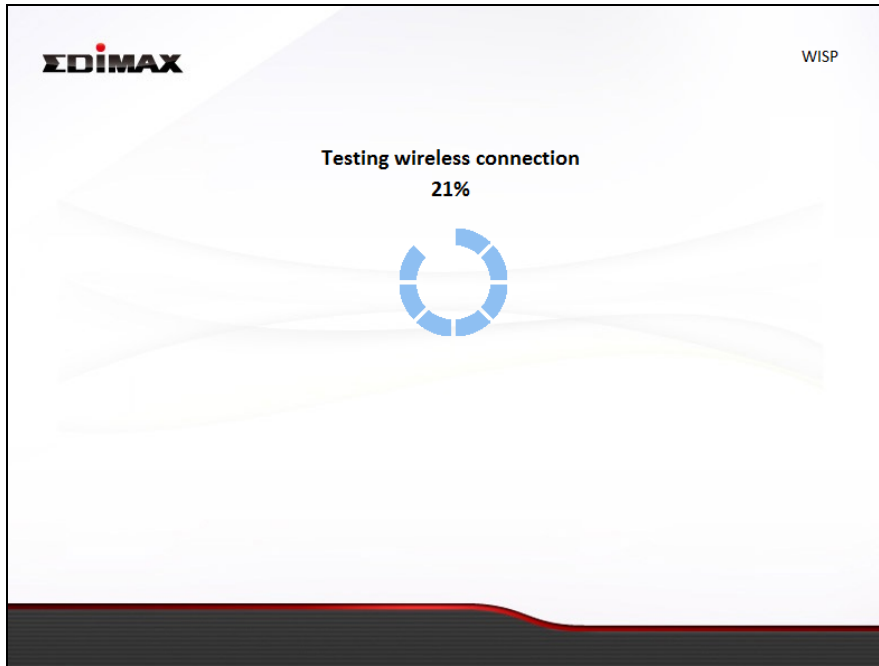

8. Click “Next” to continue your Internet service type configuration.

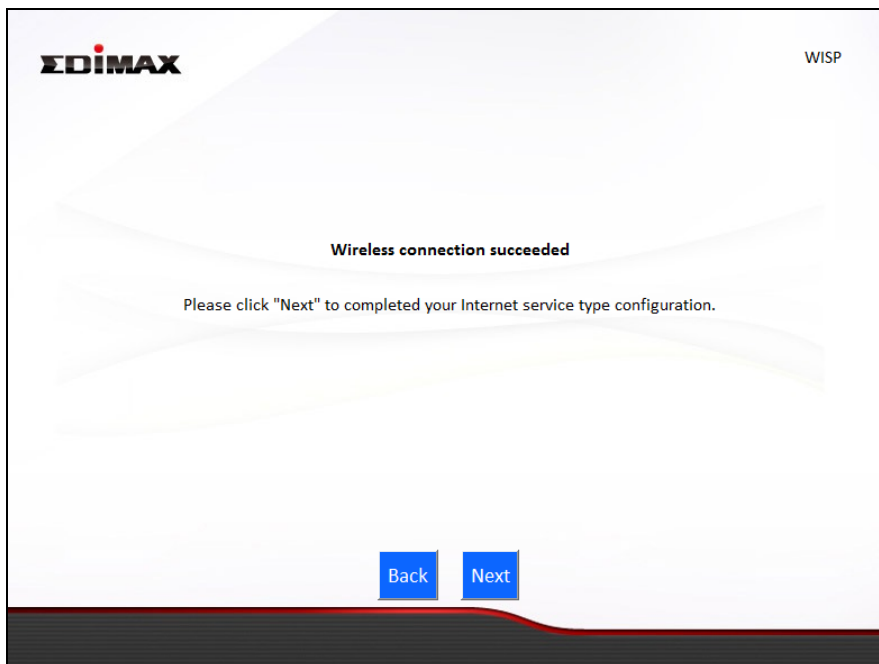

9. Wait a moment while the BR-6428nS V3/BR-6228nS V3 connects to the Internet.

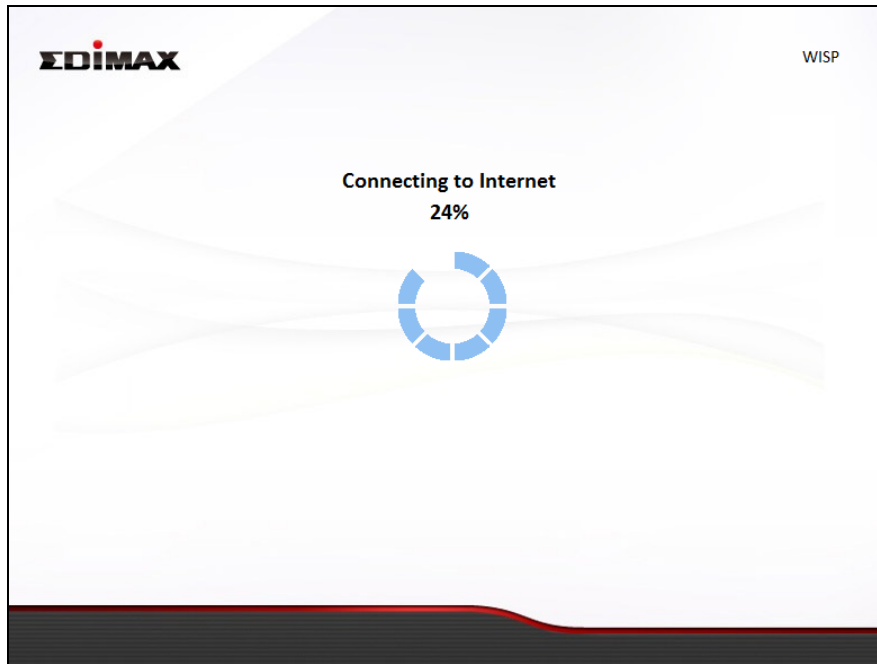

**10.** When the Internet is connected, click “Next” to configure your wireless network.

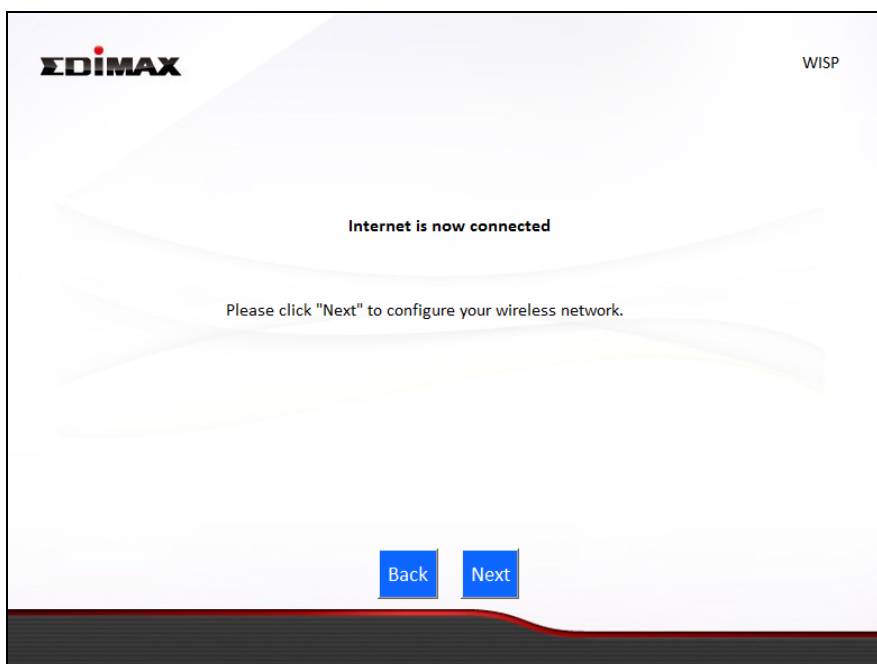

**11.** Enter a name and password for your 2.4GHz wireless network, then click “Next” to continue.

The screenshot shows the EDIMAX WISP configuration interface. At the top left is the EDIMAX logo, and at the top right is the text 'WISP'. The main heading reads 'Please set your Wi-Fi network name (SSID) and Wi-Fi password.' Below this, there are two input fields: 'Wi-Fi network name (2.4GHz):' with the value 'edimax\_2.4G\_8196D1' and 'Wi-Fi password (WPA2-AES):' with the value 'abcd1234'. A note '(at least 8 characters)' is positioned below the password field. At the bottom, there are two blue buttons labeled 'Back' and 'Next'.

**12.** A summary of your configuration will be displayed according to your connection type, as shown below. Check that all of the details are correct and then click “Next” to proceed.

The screenshot shows the EDIMAX WISP configuration interface displaying a summary of the completed configuration. At the top left is the EDIMAX logo, and at the top right is the text 'WISP'. The main heading reads 'Configuration is complete. It is recommended that you backup your settings, please click "Backup this configuration" to do so. Then click "Next" when you are ready to continue.' Below this, the configuration details are listed: 'Internet Type : PPPoE', '(2.4 GHz) Wi-Fi network name : edimax\_2.4G\_8196D1', and 'Wi-Fi password : abcd1234'. A button labeled 'Backup this configuration' is positioned below the details. At the bottom, there are two blue buttons labeled 'Back' and 'Next'.



***If you wish to backup the device’s settings, click “Backup this configuration” to open a new window and save your current configuration to a .txt file.***

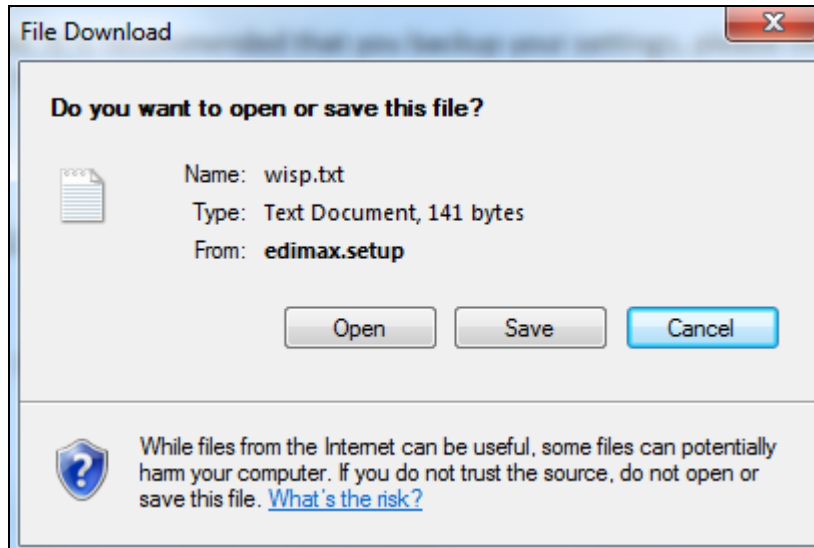

**13.** Please wait a moment until the BR-6428nS V3/BR-6228nS V3 is ready.

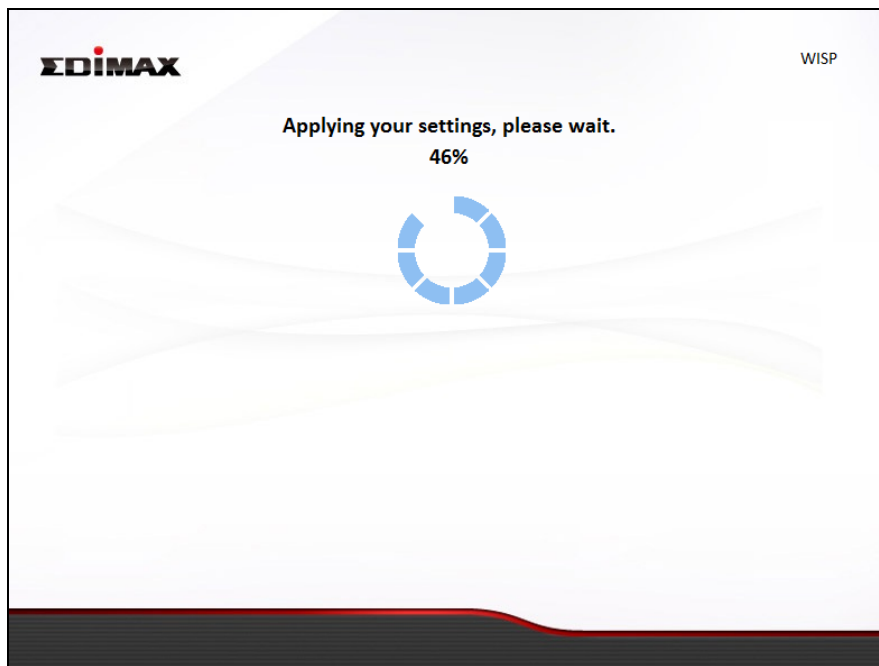

**14.** A final congratulations screen will indicate that setup is complete. You can now connect to the device's new SSID(s) which are shown on the screen then close the browser window.

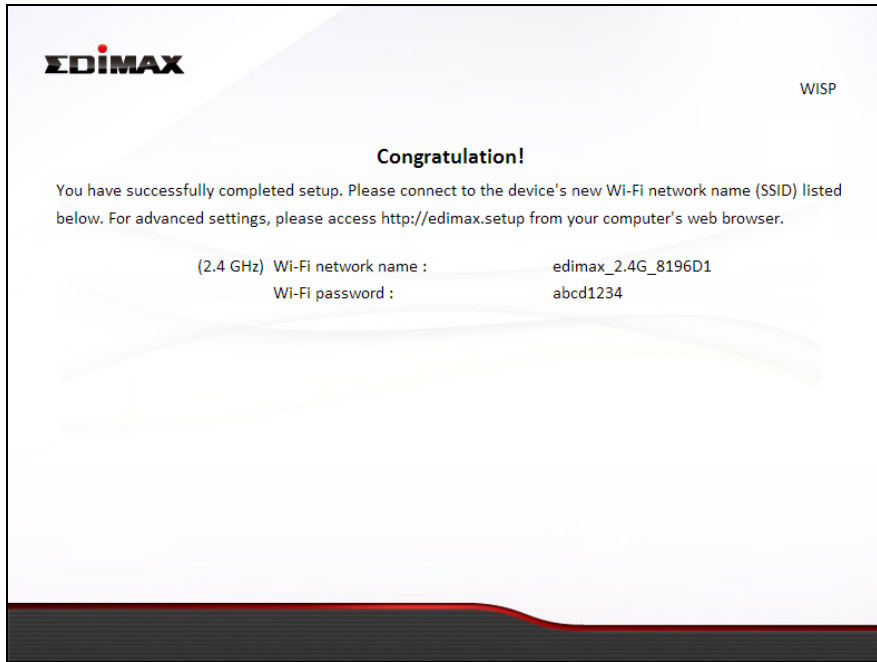

- 15.** The BR-6428nS V3/BR-6228nS V3 is working and ready for use. Refer to [IV-2. Connecting to a Wi-Fi network](#) if you require more guidance.

## II-6. WPS Setup

If your wireless device supports WPS (Wi-Fi Protected Setup) then you can use this method to connect to the BR-6428nS V3/BR-6228nS V3's Wi-Fi network.

- 1.** Press the **WPS button** on the BR-6428nS V3/BR-6228nS V3 for 2 – 5 seconds to activate WPS. The WLAN LED will flash to indicate that WPS is active.
- 2.** **Within two minutes**, press the WPS button on the **wireless device/client** to activate its WPS.
- 3.** The devices will establish a connection. Repeat for additional wireless devices.

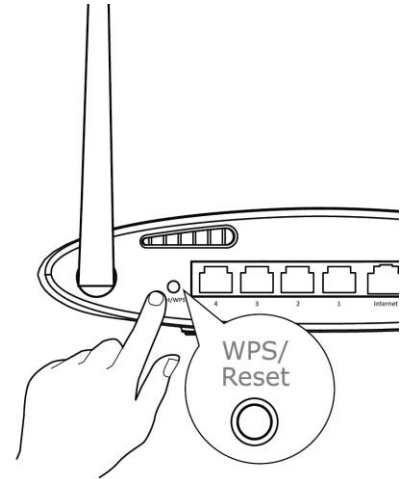

***Please check the instructions for your wireless device for how long you need to hold down its WPS button to activate WPS.***

## II-7. Reset to Factory Default Settings

If you experience problems with your BR-6428nS V3/BR-6228nS V3, you can reset the device back to its factory settings. This resets **all** settings back to default.

- 1.** Press and hold the WPS/Reset button found on the back panel for at least 10 seconds, until the power LED begins to flash.
- 2.** Release the button when the power LED is **flashing**.
- 3.** Wait for the BR-6428nS V3/BR-6228nS V3 to restart. The BR-6428nS V3/BR-6228nS V3 is ready for setup when the power LED displays **on**.



### III. *Browser Based Configuration Interface*

---

After you have setup the BR-6428nS V3/BR-6228nS V3 as detailed in **II. Installation** or the included **Quick Installation Guide**, you can use the browser based configuration interface to configure advanced settings.



***Please ensure that your computer is set to use a dynamic IP address. Refer to [IV-1. Configuring your IP address](#) for more information.***

#### III-1. Login

1. To access the browser based configuration interface enter ***http://edimax.setup*** into the URL bar of a browser on a network device connected to the same Wi-Fi network as the BR-6428nS V3/BR-6228nS V3.



***If you can not access http://edimax.setup, connect the device to a computer using an Ethernet cable and try again.***

2. You will be prompted for a username and password. The default username is “admin” and the default password is “1234”.

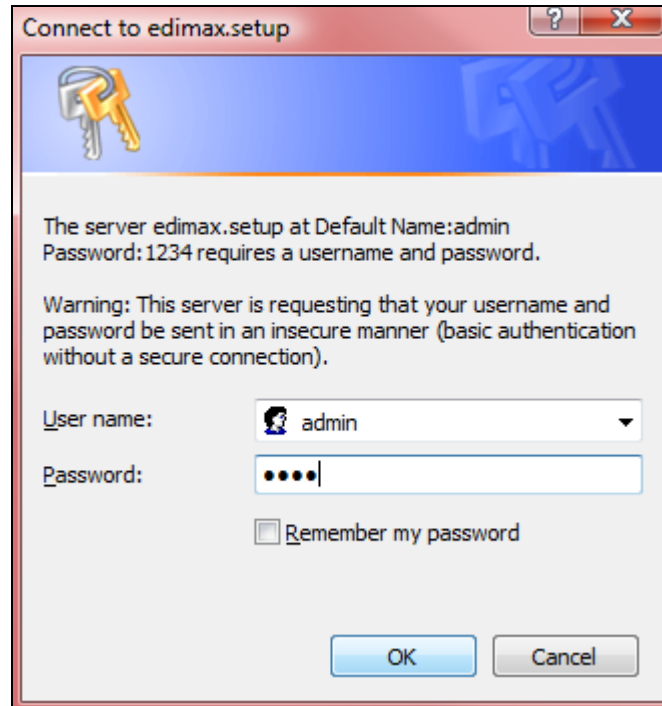

3. You will arrive at the “Status” screen. Use the menu down the left side to navigate.

EDIMAX NETWORKING PEOPLE TOGETHER Wi-Fi Router English

Help

► Status

► Setup Wizard

► Internet

► LAN

► 2.4GHz Wireless

► Firewall

► QoS

► Advanced

► Administration

System Status

System		LAN	
Model	N300 Wi-Fi Router	IP Address	192.168.2.1
Current Time	2014/8/25 20:42:42	Subnet Mask	255.255.255.0
Hardware Version	Rev. A	DHCP Server	Enable
Firmware Version	1.00	MAC Address	00:E0:4C:81:96:C1

Internet		2.4GHz Wireless	
IP Address Mode	PPPoE Connect	Mode	AP
IP Address	118.161.24.157	SSID	edimax_2.4G_8196D1
Subnet Mask	255.255.255.255	Channel Number	11
Default Gateway Address	168.95.98.254	Security	WPA2 (AES)
MAC Address	00:E0:4C:81:96:C9	MAC Address	00:E0:4C:81:96:D1
DNS 1	168.95.192.1		
DNS 2	168.95.1.1		
DNS 3	168.95.1.1		

## III-2. Save Settings

1. After you configure any settings, click the “Save Settings” button at the bottom of the screen to save your changes.



***The device needs to restart in order to bring any changes into effect.***

2. Then, click “Click here to restart” in order to restart the device and bring the changes into effect.

Settings have been saved. Please [click here to restart](#) the router and bring the new settings into effect.

3. To make several changes at once, use the “Save Settings” button after each change and then click “click here to restart” after your final change. Only one restart is necessary as long as each change is saved with the “Save Settings” button.



***After you click “click here to restart”, all saved changes will come into effect.***

### III-3. Main Menu

The main menu displays different options depending on your device's operating mode.



**For Range Extender mode: WPS please refer to 2.4GHz Wireless →**  
WPS

#### **Wi-Fi Router**

- ▶ Status
- ▶ Setup Wizard
- ▶ Internet
- ▶ LAN
- ▶ 2.4GHz Wireless
- ▶ Firewall
- ▶ QoS
- ▶ Advance
- ▶ Administration

#### **Access Point**

- ▶ Status
- ▶ Setup Wizard
- ▶ LAN
- ▶ 2.4GHz Wireless
- ▶ Advance
- ▶ Administration

#### **Range Extender**

- ▶ Status
- ▶ Setup Wizard
- ▶ WPS
- ▶ Administration

#### **Wireless Bridge**

- ▶ Status
- ▶ Setup Wizard
- ▶ Administration

#### **WISP**

- ▶ Status
- ▶ Setup Wizard
- ▶ WISP
- ▶ LAN
- ▶ 2.4GHz Wireless
- ▶ Firewall
- ▶ QoS
- ▶ Advanced
- ▶ Administration

### III-3-1. Status



The “Status” page displays basic system information about the device, arranged into four categories: System, LAN, Internet & 2.4GHz Wireless.



***Screenshots displayed are examples. The information shown on your screen will vary depending on your configuration.***

System Status

System		LAN	
Model	N300 Wi-Fi Router	IP Address	192.168.2.1
Current Time	2014/8/25 20:42:18	Subnet Mask	255.255.255.0
Hardware Version	Rev. A	DHCP Server	Enable
Firmware Version	1.00	MAC Address	00:E0:4C:81:96:C1

Internet		2.4GHz Wireless	
IP Address Mode	PPPoE Connect	Mode	AP
IP Address	118.161.24.157	SSID	edimax_2.4G_8196D1
Subnet Mask	255.255.255.255	Channel Number	11
Default Gateway Address	168.95.98.254	Security	WPA2 (AES)
MAC Address	00:E0:4C:81:96:C9	MAC Address	00:E0:4C:81:96:D1
DNS 1	168.95.192.1		
DNS 2	168.95.1.1		
DNS 3	168.95.1.1		

### III-3-2. Setup Wizard

**Setup Wizard** You can run the setup wizard again to reconfigure the basic settings of the device, or you can run a wizard to help you switch the device to a different operating mode. Select “Setup Wizard” or “Switch to Router/AP/Range Extender/Wireless Bridge/WISP mode” and then click “Run Wizard” to begin.

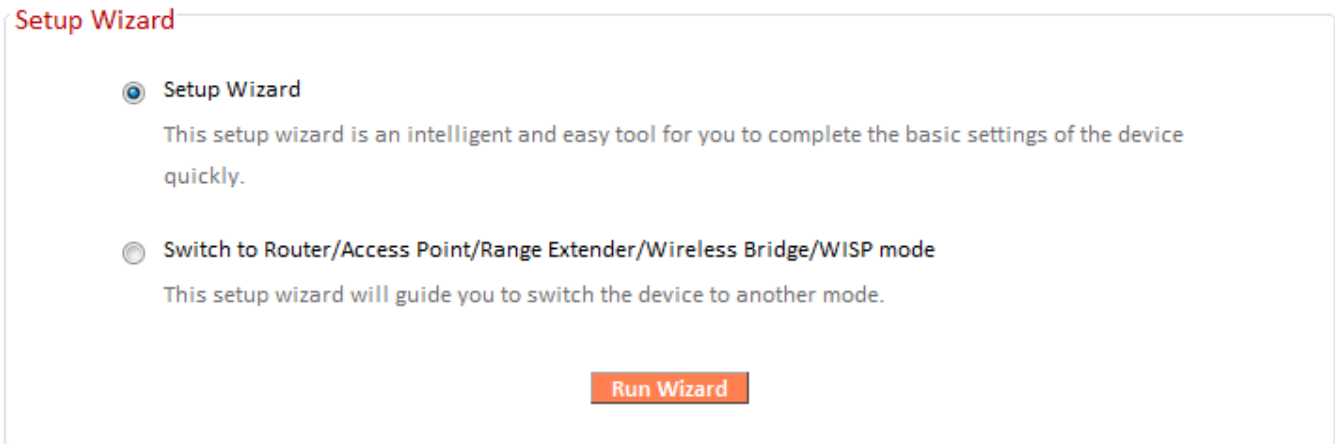

<b>Setup Wizard</b>	This wizard will help you to set up the basic functions and settings of the device. For guidance about using the setup wizard, please refer to <a href="#">II. Installation</a> .
<b>Switch to Router/Access Point/ Range Extender/ Wireless Bridge/ WISP mode</b>	This wizard will help you to switch the device to a different operating mode: Wi-Fi router mode, access point mode, range extender, wireless bridge, or WISP mode (see below).

#### Switch to Router/Access Point/ Range Extender/ Wireless Bridge/ WISP mode:

1. Follow the on-screen instructions to back up your current settings and then reset the device back to its factory default settings.
2. After the device has reset you will see the screen below. Close your browser and open it again.

### Reset to Defaults

You have successfully reset the device to factory defaults. Please close the browser and open it again. This device will start running the setup wizard for you to switch the mode.

3. Follow the on-screen wizard to setup your device in a different mode. Refer to [II. Installation Step 3](#) onwards for help if needed.



***If you don't see the "Get Started" screen, try reconnecting to the edimax.setup SSID and go to <http://edimax.setup> in a web browser.***

### III-3-3. Internet/WISP

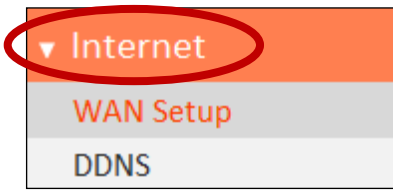

The “Internet” menu provides access to WAN and DDNS settings. Click on an item from the submenu to view and/or configure the settings.

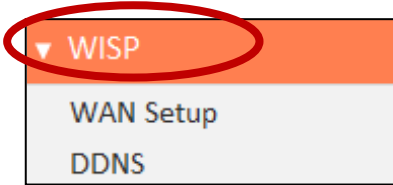

***In WISP mode, the screen below will be displayed:***

**WISP**

Enable / Disable     Disable     Enable

**Basic Settings :**

SSID   

Site Survey     2.4G   

Channel Number   

**Security Setting :**

Encryption   

Security Type     TKIP     AES

Pre-shared Key Format   

Pre-shared Key

<b>Enable / Disable</b>	Enable or disable your WISP connection.
<b>SSID</b>	The name of the WISP network which your BR-6428nS V3/BR-6228nS V3 is connected to. Manually enter an SSID if you wish or use “Site Survey” below.
<b>Site Survey</b>	Select wireless frequency and click “Select Site List” to open a new window and select your WISP network.
<b>Security Setting</b>	Please refer to <b>III-3-5-1. Basic</b> for a description of security settings.



### III-3-3-1. WAN Setup

Select a Wide Area Network (WAN) connection mode and configure the settings. If you are unsure about your connection type, contact your ISP.

The screenshot shows the WAN Connection Mode configuration interface. At the top, there is a section titled "WAN Connection Mode" with a "Connection Mode" dropdown menu. The dropdown menu is open, showing options: Dynamic IP (highlighted), Static IP, PPPoE, PPTP, L2TP, and WISP. Below this, there is a section titled "Dynamic IP" with fields for "Host Name" and "MAC Address". A "Clone MAC" button is located to the right of the MAC Address field.



***In WISP mode, only Dynamic IP, Static IP & PPPoE are available for WAN Connection Mode.***

#### III-3-3-1-1. Dynamic IP

Select "Dynamic IP". If your Internet service provider assigns IP address automatically using DHCP (Dynamic Host Configuration Protocol).

The screenshot shows the Dynamic IP configuration interface. It includes the following fields and options:

- Host Name: [Text input field]
- MAC Address: [Text input field with value 000000000000] and a "Clone MAC" button.
- DNS Address: Radio buttons for "Obtain an IP address automatically" (selected) and "Use the following IP address".
- DNS1 Address: [Text input field with value 0.0.0.0]
- DNS2 Address: [Text input field with value 0.0.0.0]
- DNS3 Address: [Text input field with value 0.0.0.0]
- DNS Proxy: Radio buttons for "Disable" (selected) and "Enable".
- DNS Proxy Rules (URL): [Text input field]
- MTU: [Text input field with value 1500] and a note "(512 <= MTU Value <= 1500)".
- TTL: Radio buttons for "Disable" (selected) and "Enable".

A "Save Settings" button is located at the bottom of the configuration area.

<b>Host Name</b>	Enter the host name of your computer.
<b>MAC Address</b>	For some applications, you may need to designate a specific MAC address for the router. Please enter the MAC address here. If you are connecting the router to a computer, press “Clone Mac” to automatically enter your computer’s MAC address.
<b>DNS Address</b>	Select “Obtain an IP address automatically” or “Use the following IP address”. Check with your ISP if you are unsure.
<b>DNS Address 1,2 &amp; 3</b>	Enter the DNS address(es) assigned by your ISP here.
<b>DNS Proxy</b>	Enable or disable a DNS proxy server.
<b>DNS Proxy Rules (URL)</b>	When DNS proxy is enabled, enter the URL of a DNS proxy server.
<b>MTU</b>	Enter the maximum transmission unit (MTU) value of your network connection. The default value is 1500.
<b>TTL</b>	Enable/Disable time to live (TTL) function which limits the lifespan of network data to improve performance.

### III-3-3-1-2. Static IP

Select “Static IP” if your ISP provides Internet access via a fixed IP address. Your ISP will provide you with such information as IP address, subnet mask, gateway address, and DNS address.

**Static IP**

Fixed IP IP Address

Subnet Mask

Default Gateway Address

MAC Address

DNS1 Address

DNS2 Address

DNS3 Address

DNS Proxy  Disable  Enable

DNS Proxy Rules (URL)

MTU  (512<= MTU Value <=1500)

TTL  Disable  Enable

<b>Fixed IP Address</b>	Input the IP address assigned by your ISP here.
<b>Subnet Mask</b>	Input the subnet mask assigned by your ISP here.
<b>Default Gateway Address</b>	Input the default gateway assigned by your ISP here. Some ISPs may call this “Default Route”.
<b>MAC Address</b>	For some applications, you may need to designate a specific MAC address for the router. Please enter the MAC address here. If you are connecting the router to a computer, press “Clone Mac” to automatically enter your computer’s MAC address.
<b>DNS Address 1, 2 &amp; 3</b>	Enter the DNS address(es) assigned by your ISP here.
<b>DNS Proxy</b>	Enable or disable a DNS proxy server.
<b>DNS Proxy Rules (URL)</b>	When DNS proxy is enabled, enter the URL of a DNS proxy server.
<b>TTL</b>	Enable/Disable time to live (TTL) function which limits the lifespan of network data to improve performance.

### III-3-3-1-3. PPPoE

Select “PPPoE” if your ISP is providing you Internet access via PPPoE (Point-to-Point Protocol over Ethernet).

PPPoE

User Name: [ ] @wifi.hinet.net

Password: [ ]

MAC Address: [000000000000] Clone MAC

DNS Address:  Obtain an IP address automatically  
 Use the following IP address

DNS1 Address: [0.0.0.0]

DNS2 Address: [0.0.0.0]

DNS3 Address: [0.0.0.0]

DNS Proxy:  Disable  Enable

DNS Proxy Rules (URL): [ ]

TTL:  Disable  Enable

Service Name: [ ]

MTU: [1392] (512<= MTU Value <=1492)

Connection Type: [Continuous] Connect Disconnect

Idle Time Out: [10] (1-1000 minutes)

Enable Dual Wan Access :

IGMP Source:  ETH  PPP

Save Settings

<b>User Name</b>	Enter the user name assigned by your ISP here.
<b>Password</b>	Enter the password assigned by your ISP here.
<b>MAC Address</b>	For some applications, you may need to designate a specific MAC address for the router. Please enter the MAC address here. If you are connecting the router to a computer, press “Clone Mac” to automatically enter your computer’s MAC address.

<b>DNS Address</b>	Select “Obtain an IP address automatically” or “Use the following IP address”. Check with your ISP if you are unsure.
<b>DNS Address 1, 2 &amp; 3</b>	Enter the DNS address(es) assigned by your ISP here.
<b>DNS Proxy</b>	Enable or disable a DNS proxy server.
<b>DNS Proxy Rules (URL)</b>	When DNS proxy is enabled, enter the URL of a DNS proxy server.
<b>Service Name</b>	Give this Internet service a name (optional).
<b>MTU</b>	Enter the maximum transmission unit (MTU) value of your network connection. The default value is 1392.
<b>Connection Type</b>	Specify a connection type: <ul style="list-style-type: none"> <li>1. “Continuous”: Connected all the time.</li> <li>2. “Connect on Demand”: Connect when you initiate an Internet connection.</li> <li>3. “Manual”: Connect/disconnect manually using the “Connect” and “Disconnect” buttons.</li> </ul>
<b>Idle Time Out</b>	Specify the amount of time the router waits before shutting down an idle connection. Only available when “Connect on Demand” (above) is selected.
<b>Enable Dual-WAN Access</b>	Enable/disable dual WAN access. When you enable dual WAN access, select an IGMP source and enter a “Host Name” and “MAC Address”.

### III-3-3-1-4. PPTP

Select “PPTP” if your ISP is providing you Internet access via PPTP (Point-to-Point Tunneling Protocol). Then select “Obtain an IP address automatically” or “Use the following IP address” depending on your ISP.

**PPTP**

Obtain an IP address automatically :

Host Name

MAC Address  [Clone MAC](#)

Use the following IP address :

Static IP Address

Subnet Mask

Default Gateway Address

MAC Address  [Clone MAC](#)

DNS Address  Obtain an IP address automatically  
 Use the following IP address

DNS1 Address

DNS2 Address

DNS3 Address

DNS Proxy  Disable  Enable

DNS Proxy Rules (URL)

**PPTP Settings :**

User ID

Password

PPTP Gateway

Connection ID  (Optional)

MTU  (512<= MTU Value <=1492)

BEZEQ-ISRAEL  Enable (for use with BEZEQ network in Israel only)

Connection Type  [Connect](#) [Disconnect](#)

Idle Time Out  (1-1000 minutes)

[Save Settings](#)

<b>Host Name</b>	Enter the host name of your computer here If required.
<b>MAC Address</b>	For some applications, you may need to designate a specific MAC address for the router. Please enter

	the MAC address here. If you are connecting the router to a computer, press “Clone Mac” to automatically enter your computer’s MAC address.
<b>Static IP Address</b>	Input the IP address assigned by your ISP here.
<b>Subnet Mask</b>	Input the subnet mask assigned by your ISP here.
<b>Default Gateway Address</b>	Input the default gateway assigned by your ISP here. Some ISPs may call this “Default Route”.
<b>MAC Address</b>	If your ISP filters access by MAC addresses, enter your computer’s MAC address here. Click “Clone MAC” to automatically enter your computer’s MAC address.
<b>DNS Address</b>	Select “Obtain an IP address automatically” or “Use the following IP address”. Check with your ISP if you are unsure.
<b>DNS Address 1,2 &amp; 3</b>	Enter the DNS address(es) assigned by your ISP here.
<b>DNS Proxy</b>	Enable or disable a DNS proxy server.
<b>DNS Proxy Rules (URL)</b>	When DNS proxy is enabled, enter the URL of a DNS proxy server.
<b>User ID</b>	Input the user name assigned by your ISP here.
<b>Password</b>	Input the password assigned by your ISP here.
<b>PPTP Gateway</b>	Input the PPTP gateway assigned by your ISP here.
<b>Connection ID</b>	Specify a reference name/ID for the connection.
<b>MTU</b>	Enter the maximum transmission unit (MTU) value of your network connection. The default value is 1392.
<b>BEZEQ-ISRAEL</b>	Check the “Enable” box if you are using BEZEQ network services (Israel users only).
<b>Connection Type</b>	Specify a connection type:  <ol style="list-style-type: none"> <li>1. “Continuous”: Connected all the time.</li> <li>2. “Connect on Demand”: Connect when you initiate an Internet connection.</li> <li>3. “Manual”: Connect/disconnect manually using the “Connect” and “Disconnect” buttons.</li> </ol>
<b>Idle Time Out</b>	Specify the amount of time the router waits before shutting down an idle connection. Only available when “Connect on Demand” (above) is selected.

### III-3-3-1-5. L2TP

Select “L2TP” if your ISP is providing you Internet access via L2TP (Layer 2 Tunneling Protocol).

**L2TP**

Obtain an IP address automatically :

Host Name

MAC Address  Clone MAC

Use the following IP address :

Static IP Address

Subnet Mask

Default Gateway Address

MAC Address  Clone MAC

DNS Address  Obtain an IP address automatically  
 Use the following IP address

DNS1 Address

DNS2 Address

DNS3 Address

DNS Proxy  Disable  Enable

DNS Proxy Rules (URL)

**L2TP Settings :**

User ID

Password

L2TP Gateway

MTU  (512<= MTU Value <=1492)

Connection Type  Connect Disconnect

Idle Time Out  (1-1000 minutes)

Save Settings

<b>Host Name</b>	Enter the host name of your computer here If required.
<b>MAC Address</b>	For some applications, you may need to designate a specific MAC address for the router. Please enter the MAC address here. If you are connecting the router to a computer, press “Clone Mac” to automatically enter your computer’s MAC address.



<b>Static IP Address</b>	Input the IP address assigned by your ISP here.
<b>Subnet Mask</b>	Input the subnet mask assigned by your ISP here.
<b>Default Gateway Address</b>	Input the default gateway assigned by your ISP here. Some ISPs may call this "Default Route".
<b>MAC Address</b>	If your ISP filters access by MAC addresses, enter your computer's MAC address here. Click "Clone MAC" to automatically enter your computer's MAC address.
<b>DNS Address</b>	Select "Obtain an IP address automatically" or "Use the following IP address". Check with your ISP if you are unsure.
<b>DNS Address 1,2 &amp; 3</b>	Enter the DNS address(es) assigned by your ISP here.
<b>DNS Proxy</b>	Enable or disable a DNS proxy server.
<b>DNS Proxy Rules (URL)</b>	When DNS proxy is enabled, enter the URL of a DNS proxy server.
<b>User ID</b>	Input the user name assigned by your ISP here.
<b>Password</b>	Input the password assigned by your ISP here.
<b>L2TP Gateway</b>	Input the L2TP gateway assigned by your ISP here.
<b>Connection ID</b>	Specify a reference name/ID for the connection.
<b>MTU</b>	Enter the maximum transmission unit (MTU) value of your network connection. The default value is 1392.
<b>Connection Type</b>	Specify a connection type: <ol style="list-style-type: none"> <li>1. "Continuous": Connected all the time.</li> <li>2. "Connect on Demand": Connect when you initiate an Internet connection.</li> <li>3. "Manual": Connect/disconnect manually using the "Connect" and "Disconnect" buttons.</li> </ol>
<b>Idle Time Out</b>	Specify the amount of time the router waits before shutting down an idle connection. Only available when "Connect on Demand" (above) is selected.

### III-3-3-1-6. WISP

Select “WISP” if you use a wireless internet service from Internet Service Provider (WISP).

**WISP**

Enable / Disable     Disable  Enable

**Basic Settings :**

ESSID   

Site Survey   

Channel Number   

**Security Setting :**

Encryption     ▾

<b>WISP</b>	Enable or disable the WISP function.
<b>SSID</b>	Enter the SSID of the WISP network, or click “Select Site Survey” below to view all available networks in a new window and select the WISP network from there.
<b>Select Site Survey</b>	Click “Select Site Survey” to display all available wireless SSIDs in a new window and select your WISP network.
<b>Channel Number</b>	Enter the channel number of the WISP network.
<b>Security Settings</b>	Enter the security information required by your ISP.

### III-3-3-2. DDNS

Dynamic DNS (DDNS) is a service which provides a hostname-to-IP service for dynamic IP users. The changing nature of dynamic IPs means that it can be difficult to access a service provided by a dynamic IP user; a DDNS service though can map such dynamic IP addresses to a fixed hostname, for easier access. The router supports several DDNS service providers, for more details and to register for a DDNS account please visit the DDNS providers website(s), examples of which are listed below.

DDNS

Enable / Disable     Enable  Disable

Provider   

Domain Name   

Account / E-mail   

Password / Key   

<b>Enable/Disable</b>	Enable or disable DDNS
<b>Provider</b>	Select DDNS service provider.
<b>Domain Name</b>	Enter the domain name provided by the DDNS provider.
<b>Account/Email</b>	Please enter the DDNS registration account/email.
<b>Password/Key</b>	Enter the DDNS service password/key.

The following DDNS services are supported:

- 3322**            <http://www.3322.org>
- DHS**            <http://www.dhs.org>
- DynDNS**        <http://www.dyndns.org>
- ODS**            <http://ods.org>
- TZO**            <http://www.tzo.com>
- GnuDIP**        <http://gnudip2.sourceforge.net>
- DyNS**           <http://www.dyns.cx/>
- ZoneEdit**      <http://www.zoneedit.com>
- CyberGate**    <http://cybergate.planex.co.jp/ddns/>

**NS2GO**

*<http://www.ns2go.com/>*

**NO-IP**

*<http://www.noip.com/>*

### III-3-4. LAN



You can configure your Local Area Network (LAN) on this page. You can enable the router to dynamically allocate IP addresses to your LAN clients, and you can modify the IP address of the device. The device’s default IP address is 192.168.2.1.



***You can access the browser based configuration interface using the device’s IP address instead of using the URL <http://edimax.setup>.***

LAN IP

IP Address	<input type="text" value="192.168.2.1"/>
Subnet Mask	<input type="text" value="255.255.255.0"/>
802.1d Spanning Tree	<input type="text" value="Disable"/> ▼
DHCP Server	<input type="text" value="Enable"/> ▼
Lease Time	<input type="text" value="One hour"/> ▼

<b>IP Address</b>	Specify the IP address here. This IP address will be assigned to the BR-6428nS V3/BR-6228nS V3 and will replace the default IP address.
<b>Subnet Mask</b>	Specify a subnet mask. The default value is 255.255.255.0
<b>802.1d Spanning Tree</b>	Select “Enable” or “Disable” to enable/disable 802.1d Spanning Tree. This creates a tree of connected layer-2 bridges (typically Ethernet switches) within a mesh network, and disables those links that are not part of the tree, leaving a single active path between any two network nodes.
<b>DHCP Server</b>	Enable or disable the DHCP server.
<b>Lease Time</b>	Select a lease time for the DHCP leases here. The DHCP client will obtain a new IP address after the period expires.

Your device’s DHCP server automatically assigns IP addresses to computers on its network, between a defined range of numbers.

**DHCP Server**

Start IP

End IP

<b>Start IP</b>	Enter the start IP address for the DHCP server's IP address leases.
<b>End IP</b>	Enter the end IP address for the DHCP server's IP address leases.

Your device's DHCP server can be configured to assign static (fixed) IP addresses to specified network devices, identified by their unique MAC address.

**Static DHCP Lease Table**

Only 16 sets of addresses are allowed.

NO.	MAC Address	IP Address	Select
1	00:1b:63:cb:4c:b5	192.168.2.110	<input type="checkbox"/>

Enable Static DHCP Leases

<b>Enable Static DHCP Leases</b>	Enable/disable static DHCP leases. This must be enabled in order to assign any network device a static IP address.
<b>MAC Address</b>	Enter the specified network device's MAC address here.
<b>IP Address</b>	Assign a fixed IP address for the specified network device here.
<b>Add</b>	Add the information to the "Static DHCP Leases Table".
<b>Clear</b>	Clear the MAC address and IP address fields.
<b>Delete Selected / Delete All</b>	Delete selected or all entries from the table.



**The LAN IP page will be displayed as below when your device is set to access point mode. You can set the BR-6428nS V3/BR-6228nS V3 to obtain an IP address automatically or you can specify an IP address.**

## LAN IP

Obtain an IP address automatically

Use the following IP address

IP Address

Subnet Mask

Default Gateway Address

### III-3-5. 2.4GHz Wireless



The “2.4GHz Wireless” menu allows you to configure SSID and security settings for your Wi-Fi network along with a guest Wi-Fi network. WPS, access control and scheduling functions can also be managed from here.

#### Access Point Mode:

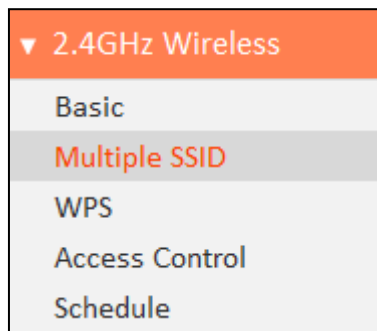

***In Access Point mode, the “Guest” feature in the menu is replaced by “Multiple SSID”.***

#### III-3-5-1. Basic

The “Basic” screen displays settings for your primary 2.4GHz Wi-Fi network.

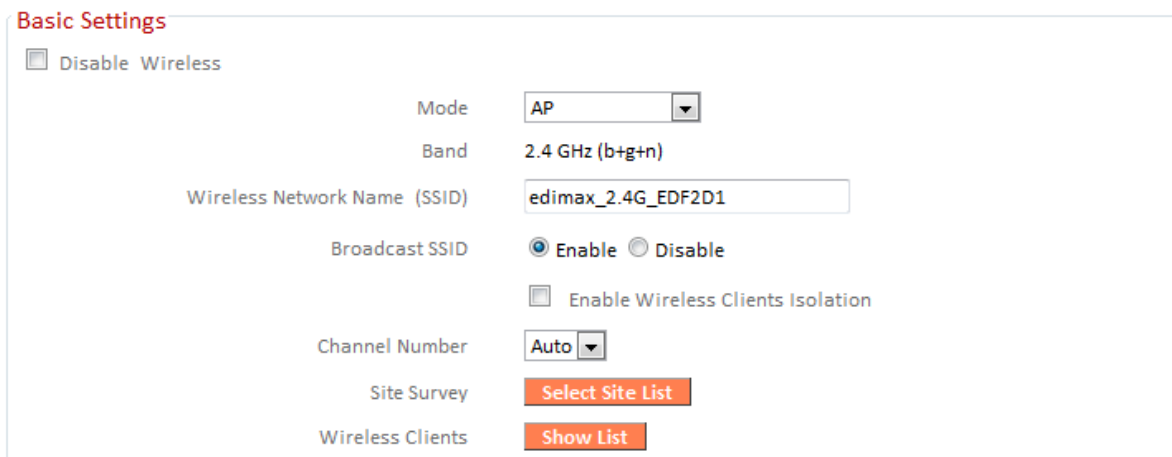

<b>Disable Wireless</b>	Check the box to disable the wireless function of your device.
<b>Mode</b>	Keep the default “AP” value for the device to act as a standard wireless access point, or



	select “AP Bridge-WDS” for the device to function in WDS mode (see below).
<b>Band</b>	Displays the wireless standard used for the BR-6428nS V3/BR-6228nS V3’s “2.4GHz (B+G+N)” means that 802.11b, 802.11g, and 802.11n wireless clients can connect to the BR-6428nS V3/BR-6228nS V3.
<b>Wireless Network Name (SSID)</b>	This is the name of your Wi-Fi network for identification, also sometimes referred to as “SSID”. The SSID can consist of any combination of up to 32 alphanumerical characters.
<b>Broadcast SSID</b>	Enable or disable SSID broadcast. When enabled, the SSID will be visible to clients as an available Wi-Fi network. When disabled, the SSID will not be visible as an available Wi-Fi network to clients – clients must manually enter the SSID in order to connect. A hidden (disabled) SSID is typically more secure than a visible (enabled) SSID.
<b>Enable Wireless Clients Isolation</b>	Check the box to enable wireless clients isolation. This prevents wireless clients connected to the BR-6428nS V3/BR-6228nS V3 from communicating with each other and improves security. Typically, this function is useful for corporate environments or public hot spots and can prevent brute force attacks on clients’ usernames and passwords.
<b>Channel Number</b>	Select a wireless radio channel or use the default “Auto” setting from the drop-down menu.
<b>Site Survey</b>	Click “Select Site List” to display a new window showing information about the surrounding wireless environment. This information is useful to select an effective wireless channel number.
<b>Wireless Clients</b>	Click “Show List” to display a new window showing information about wireless clients. Please disable any pop-up blockers if you have difficulty using this function.

## AP Bridge-WDS:

Mode	AP Bridge-WDS
Band	AP AP Bridge-WDS

Wireless Distribution System (WDS) can bridge/repeat access points together in an extended network. WDS settings can be configured as shown below.



**When using WDS, configure the IP address of each access point to be in the same subnet and ensure there is only one active DHCP server among connected access points, preferably on the WAN side.**

WDS must be configured on each access point, using correct MAC addresses. All access points should use the same wireless channel.

MAC Address 1	000000000000
MAC Address 2	000000000000
MAC Address 3	000000000000
MAC Address 4	000000000000
Set Security	<b>Set Security</b>

<b>MAC Address 1 - 4</b>	Enter the correct MAC address for other access points in WDS mode.
<b>Set Security</b>	Click “Set Security” to open a new window and enter the security settings for WDS (shown below). Click “Save” when finished.



**Please ensure you setup and save wireless security settings before you click “Set Security” to set WDS security settings.**

## AP Bridge-WDS Security Setting

Encryption

WPA Unicast Cipher Suite  WPA2 (AES)

Pre-shared Key Format

Pre-shared Key

### Wireless Security:

Wireless Security

Encryption

Key Length

Key Format

Encryption Key   Hide

Enable 802.1x Authentication

Select an encryption type from the drop-down menu:



***“WPA Pre-shared Key” is the recommended and most secure encryption type.***



***In WISP mode, WPA RADIUS is unavailable for the wireless band that is used to connect to WISP’s AP.***

Wireless Security

Encryption

Enable 802.1x Authentication

- Disable
- WEP
- WPA Pre-shared Key
- WPA RADIUS

### III-3-5-1-1. Disable

Encryption is disabled and no password/key is required to connect to the BR-6428nS V3/BR-6228nS V3.



***Disabling wireless encryption is not recommended. When disabled, anybody within range can connect to your device's SSID.***

<b>Enable 802.1x Authentication</b>	Check the box to enable the 802.1x authentication. A RADIUS server is required to perform 802.1x authentication: enter the RADIUS server's information in the relevant fields (below).
-------------------------------------	--

Enable 802.1x Authentication

RADIUS Server IP address

RADIUS Server Port

RADIUS Server Password

### III-3-5-1-2. WEP

WEP (Wired Equivalent Privacy) is a basic encryption type. For a higher level of security consider using WPA encryption.

Wireless Security

Encryption:

Key Length:

Key Format:

Encryption Key:   Hide

Enable 802.1x Authentication

<b>Key Length</b>	Select 64-bit or 128-bit. 128-bit is more secure than 64-bit.
<b>Key Format</b>	Choose from “ASCII” (any alphanumerical character 0-9, a-z and A-Z) or “Hex” (any characters from 0-9, a-f and A-F).
<b>Encryption Key</b>	Enter your encryption key/password according to the format you selected above. A complex, hard-to-guess key is recommended. Check the “Hide” box to hide your password from being displayed on-screen.
<b>Enable 802.1x Authentication</b>	Check the box to enable the 802.1x authentication. A RADIUS server is required to perform 802.1x authentication: enter the RADIUS server’s information in the relevant fields (below).

Enable 802.1x Authentication

RADIUS Server IP address:

RADIUS Server Port:

RADIUS Server Password:

### III-3-5-1-3. WPA Pre-Shared Key

WPA pre-shared key is the recommended and most secure encryption type.

**Wireless Security**

Encryption:

WPA Unicast Cipher Suite:  WPA (TKIP)  WPA2 (AES)  WPA2 Mixed

Pre-shared Key Format:

Pre-shared Key:   Hide

<b>WPA Unicast Cipher Suite</b>	Select from WPA (TKIP), WPA2 (AES) or WPA2 Mixed. WPA2 (AES) is safer than WPA (TKIP), but not supported by all wireless clients. Please make sure your wireless client supports your selection. WPA2 (AES) is recommended followed by WPA2 Mixed if your client does not support WPA2 (AES).
<b>Pre-shared Key Format</b>	Choose from “Passphrase” (8-63 alphanumeric characters) or “Hex” (up to 64 characters from 0-9, a-f and A-F).
<b>Pre-shared Key</b>	Please enter a key according to the format you selected above. A complex, hard-to-guess key is recommended. Check the “Hide” box to hide your password from being displayed on-screen.

### III-3-5-1-4. WPA Radius

WPA RADIUS is a combination of WPA encryption and RADIUS user authentication. If you have a RADIUS authentication server, you can authenticate the identity of every wireless client against a user database.

**Wireless Security**

Encryption:

WPA Unicast Cipher Suite:  WPA (TKIP)  WPA2 (AES)  WPA2 Mixed

RADIUS Server IP address:

RADIUS Server Port:

RADIUS Server Password:

<b>WPA Unicast Cipher Suite</b>	Select from WPA (TKIP), WPA2 (AES) or WPA2 Mixed. WPA2 (AES) is safer than WPA (TKIP), but not supported by all wireless clients. Please make sure your wireless client supports your selection. WPA2 (AES) is recommended followed by WPA2 Mixed if your client does not support WPA2 (AES).
<b>RADIUS Server IP address</b>	Input the IP address of the RADIUS authentication server here.
<b>RADIUS Server Port</b>	Input the port number of the RADIUS authentication server here. The default value is 1812.
<b>RADIUS Server Password</b>	Input the password of the RADIUS authentication server here.

### III-3-5-2. Guest/ Multiple SSID

You can setup an additional “Guest” Wi-Fi network so guest users can enjoy Wi-Fi connectivity without accessing your primary network. The “Guest” screen displays settings for your guest Wi-Fi network.

 ***The guest network is separate from your primary network. The settings for your primary network can be found in the “Basic” menu.***

 ***In access point mode, the “Guest” feature in the menu is replaced by “Multiple SSID”. The BR-6428nS V3/BR-6228nS V3 supports up to four additional SSIDs for each wireless band in access point mode.***

**Guest Basic Settings**

Enable Guest SSID

Wireless Guest Name:

Enable Wireless Clients Isolation

Band: 2.4 GHz (b+g+n)

Channel Number:  (Same as main SSID)

**Guest Wireless Security**

Encryption:

Enable 802.1x Authentication

 ***802.1x authentication is unavailable in WISP mode for the wireless band that is used to connect to WISP’s AP.***

<b>Enable Guest SSID</b>	Check/uncheck the box to enable/disable the guest Wi-Fi network.
<b>Wireless Guest Name</b>	Enter a reference/ID name for your guest wireless network.
<b>Enable Wireless Clients Isolation</b>	Check the box to enable wireless clients isolation. This prevents wireless clients connected to the BR-6428nS V3/BR-6228nS V3 from communicating with each other and improves security. Typically, this function is useful for corporate environments or public hot spots and can prevent brute force attacks on clients’ usernames and passwords.



<b>Band</b>	Displays the wireless standard used for the BR-6428nS V3/BR-6228nS V3's frequency band: 2.4GHz (B+G+N): Allows 802.11b, 802.11g, and 802.11n wireless clients to connect to the BR-6428nS V3/BR-6228nS V3.
<b>Channel Number</b>	Channel number for the guest network is the same as the main SSID and cannot be adjusted independently.
<b>Encryption</b>	Please refer to <a href="#"><u>III-3-5-1. Basic: Wireless Security</u></a> for details about security settings.



**WPA RADIUS encryption type is not available for the guest network.**

### MULTIPLE SSID:

The BR-6428nS V3/BR-6228nS V3 supports up to four additional SSIDs for each wireless band in access point mode. Once configured, these SSIDs are displayed in the “Multiple SSID Status” table as shown below. Use the “Multiple SSID Basic Settings” box to configure additional SSIDs.

#### Multiple SSID Status

NO.	Enable	SSID	VLAN ID	Encryption	MAC Address
1	<input checked="" type="checkbox"/>	edimax.1	0	Disable	80:1F:02:ED:F2:D2
2	<input checked="" type="checkbox"/>	edimax.2	0	WPA2 (AES)	80:1F:02:ED:F2:D3
3	<input checked="" type="checkbox"/>	VLAN	1	WPA2 (AES)	80:1F:02:ED:F2:D4
4	<input type="checkbox"/>	edimax.4	0	Disable	80:1F:02:ED:F2:D5

#### Multiple SSID Basic Settings

Multiple SSID	1 ( MAC Address : 80:1F:02:ED:F2:D2 )
Wireless Network Name (SSID)	edimax.1
	<input checked="" type="checkbox"/> Enable Multiple SSID
	<input type="checkbox"/> Enable Wireless Clients Isolation
Band	2.4 GHz (b+g+n)
Channel Number	Auto (Same as main SSID)
VLAN ID	0 (Untagged:0, Tagged:1~4094)

<b>Multiple SSID</b>	Use the drop down menu to select which SSID ( numbered 1 – 4) to configure.
<b>Wireless Network Name (SSID)</b>	Enter a reference/ID name to separate your wireless network.
<b>Enable Multiple SSID</b>	Check/uncheck this box to enable/disable the specified SSID. Must be checked for the SSID to function.
<b>Enable Wireless Clients Isolation</b>	Check the box to enable wireless clients isolation. This prevents wireless clients connected to the BR-6428nS V3/BR-6228nS V3 from communicating with each other and improves security. Typically, this function is useful for corporate environments or public hot spots and can prevent brute force attacks on clients' usernames and passwords.
<b>Band</b>	Displays the wireless standard used for the BR-6428nS V3/BR-6228nS V3's frequency band: 2.4GHz (B+G+N): Allows 802.11b, 802.11g, and 802.11n wireless clients to connect to the BR-6428nS V3/BR-6228nS V3.
<b>Channel Number</b>	Channel number for the guest network is the same as the main SSID and cannot be adjusted independently.
<b>VLAN ID</b>	Set a VLAN ID for the specified SSID (see below).



***A VLAN is a local area network which maps workstations virtually instead of physically and allows you to group together or isolate users from each other. VLAN IDs 1 – 4094 are supported.***

### III-3-5-3. WPS

Wi-Fi Protected Setup is a simple way to establish connections between WPS compatible devices. WPS can be activated on compatible devices by pushing a WPS button on the device or from within the device’s firmware/configuration interface. When WPS is activated in the correct manner and at the correct time for two compatible devices, they will automatically connect. PIN code WPS includes the use of a PIN code between the two devices for verification.

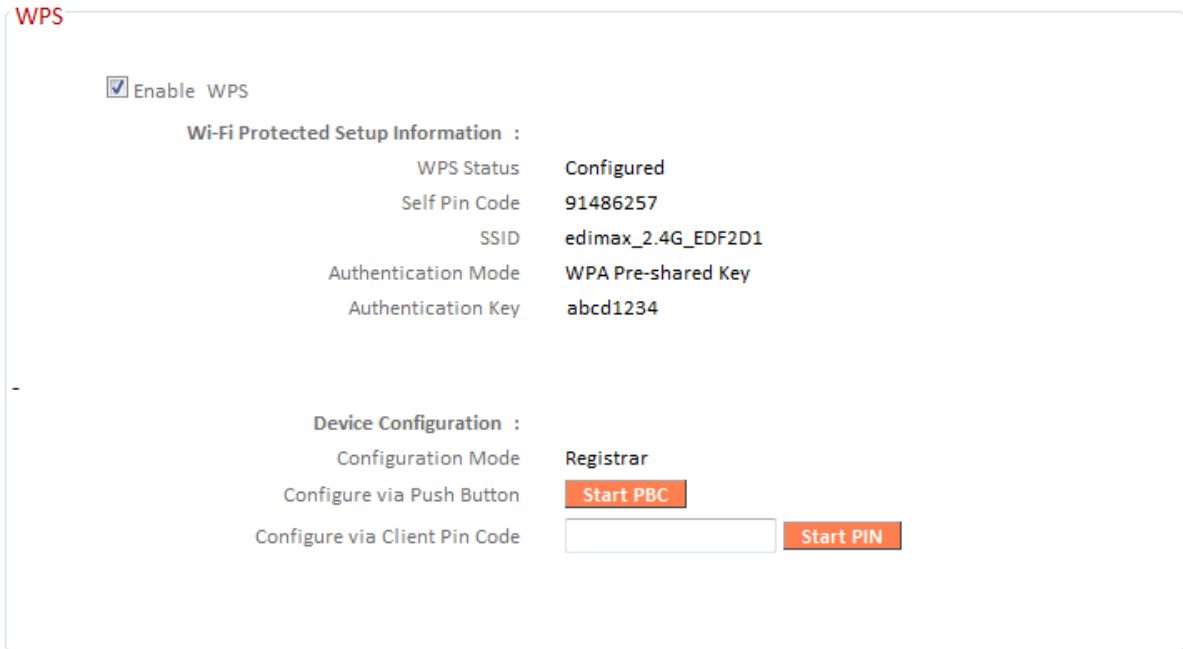

<b>Enable WPS</b>	Check/uncheck this box to enable/disable WPS.
<b>WPS Status</b>	Displays “Configured” or “unConfigured” depending on whether WPS and SSID/security settings for the device have been configured or not, either manually or using the WPS button.
<b>Self PIN Code</b>	Displays the WPS PIN code of the device.
<b>SSID</b>	Displays the SSID of the device.
<b>Authentication Mode</b>	Displays the wireless security authentication mode of the device.
<b>Authentication Key</b>	Displays the wireless security authentication key.
<b>Configuration Mode</b>	The configuration mode of the device’s WPS setting is displayed here. “Registrar” means the device acts as an access point for a wireless client to connect to and the wireless client(s) will follow the device’s wireless settings.

<b>Configure via Push Button</b>	Click “Start PBC” (Push-Button Configuration) to activate WPS on the access point. WPS will be active for 2 minutes.
<b>Configure via Client PIN Code</b>	Enter the wireless client’s PIN code here and click “Start PIN” to activate PIN code WPS. Refer to your wireless client’s documentation if you are unsure of its PIN code.

### III-3-5-4. Access Control

Access Control is a security feature that can help to prevent unauthorized users from connecting to your wireless router.

This function allows you to define a list of network devices permitted to connect to the BR-6428nS V3/BR-6228nS V3. Devices are each identified by their unique MAC address. If a device which is not on the list of permitted MAC addresses attempts to connect to the BR-6428nS V3/BR-6228nS V3, it will be denied.

To enable this function, check the box labeled “Enable Wireless Access Control”.

**Access Control**

Enable Wireless Access Control

MAC Address: ---Select--- >>   Comment:  Add

MAC Address	Device Name	IP Address	Comment	Select
<span>Delete Selected</span> <span>Delete All</span>				

Save Settings

<b>MAC address</b>	<p>Select a PC name from the drop-down list and click “&gt;&gt;” to add enter it into the blank field to the right.</p> <p>Click “Refresh’ in the drop-down menu to refresh the list of available MAC addresses. If the address you wish to add is not listed, enter</p>
--------------------	--

	<p>it manually.</p> <p>Enter a MAC address of computer or network device manually without dashes or colons e.g. for MAC address 'aa-bb-cc-dd-ee-ff' enter 'aabbccddeeff'.</p>
<b>Comment</b>	Enter a comment for reference/identification consisting of up to 16 alphanumerical characters.
<b>Add</b>	Click "Add" to add the MAC address to the MAC address filtering table.

MAC address entries will be listed in the table as shown below. Select an entry using the "Select" checkbox.

MAC Address	Device Name	IP Address	Comment	Select
00:1b:63:cb:4c:b5	MACBOOK-4729BA	192.168.2.101		<input type="checkbox"/>

Delete Selected Delete All

<b>Delete Selected/ Delete All</b>	Delete selected or all entries from the table.
--	--

### III-3-5-5. Schedule

The schedule feature allows you to automate the wireless radio to switch on/off at specified times. Multiple schedules can be configured. Check/uncheck the box “Enable Schedule Settings” to enable/disable the wireless on/off scheduling function.



***The BR-6428nS V3/BR-6228nS V3 must remain connected to the Internet and use an NTP server for the schedule feature to function correctly.***

**Wireless Schedule**

Enable Schedule Settings

1. Weekday  Sunday  Monday  Tuesday  Wednesday  
 Thursday  Friday  Saturday

2. Time Hour  Minute

3. Command

Weekday	Time	Command	Select
Monday,Tuesday,Wednesday,Thursday,Friday	01:00	wireless off	<input type="checkbox"/>
Monday,Tuesday,Wednesday,Thursday,Friday	08:00	wireless on	<input type="checkbox"/>

Settings have been saved. Please [click here to restart](#) the router and bring the new settings into effect.



***Wireless scheduling can save energy and increase the security of your network.***

- 1.** Use the checkboxes to select which day(s) to include in the schedule.
- 2.** Specify a time (hour and minute) for the schedule using the drop-down menu.
- 3.** Select which command applies to this schedule from the drop-down menu, either “Wireless On” or “Wireless Off”.

**Add**

Add the schedule to the table of active schedules.

Active schedules will be displayed in the table as shown below. Select an entry using the “Select” checkbox.

Weekday	Time	Command	Select
Monday,Tuesday,Wednesday,Thursday,Friday	01:00	wireless off	<input type="checkbox"/>
Monday,Tuesday,Wednesday,Thursday,Friday	08:00	wireless on	<input type="checkbox"/>

[Delete Selected](#) [Delete All](#)

[Save Settings](#)

Settings have been saved. Please [click here to restart](#) the router and bring the new settings into effect.

**Delete Selected/  
Delete All**

Delete selected or all entries from the table.

### III-3-6. Firewall

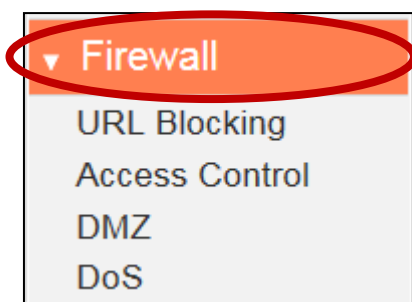

The “Firewall” menu provides access to URL blocking, access control, DMZ and DoS functions to improve the security of your wireless network.

**Firewall**

The router provides stateful packet inspection (SPI) firewall protection. Only packets matching a known active connection will be allowed by the firewall; others will be rejected.

SPI firewall  Enable  Disable

<b>SPI firewall</b>	Enable or disable the Stateful Packet Inspection (SPI) firewall.
---------------------	--

#### III-3-6-1. URL Blocking

This function can block Internet access by either specific URLs or keywords. Check/uncheck the “Enable URL Blocking” box to enable/disable URL blocking.

**URL Blocking**

Enable URL Blocking

URL / Keyword :

NO.	URL / Keyword	Select
1	www.blockedwebsite.com	<input type="checkbox"/>

Settings have been saved. Please [click here to restart](#) the router and bring the new settings into effect.



<b>URL/Keyword</b>	Enter the URL or keyword to be blocked.
<b>Add</b>	Add the URL or keyword to the blocked table.

Blocked URLs/keywords entries will be listed in the table as shown below. Select an entry using the “Select” checkbox.

NO.	URL / Keyword	Select
1	www.blockedwebsite.com	<input type="checkbox"/>

Delete Selected Delete All

Save Settings

Settings have been saved. Please [click here to restart](#) the router and bring the new settings into effect.

<b>Delete Selected / Delete All</b>	Delete selected or all entries from the table.
-------------------------------------	--

### III-3-6-2. Access Control



**Access Control (MAC filtering) can also be configured from [III-3-5-4. Access Control](#).**

Access Control is a security feature that can help to prevent unauthorized users from connecting to your wireless router.

This function allows you to define a list of network devices permitted or denied to connect to the BR-6428nS V3/BR-6228nS V3. Devices are each identified by their unique MAC address or IP address. Specific services can also be allowed/denied for IP addresses.

Check/uncheck the “Enable MAC Filtering” and/or “Enable IP Filtering” box to enable/disable MAC filtering and/or IP filtering.

#### Access Control

Enable MAC Filtering :  Deny  Allow

Client PC	MAC Address	Computer Name	Comment
<input type="text"/>	<input type="text"/>	<< ---- Select----	<input type="text"/>

MAC Filtering Table :

NO	Computer Name	Client PC MAC Address	Comment	Select
1	MACBOOK-4729BA	00:1b:63:cb:4c:b5		<input type="checkbox"/>

Enable IP Filtering Table :  Deny  Allow

IP Filtering Table :

NO	Client PC Description	Client PC IP Address	Client Service	Protocol	Port Range	Select
1	Laptop	192.168.2.101	WWW, E-mail Sending, News Forums, E-mail Receiving, Secure HTTP, File Transfer			<input type="checkbox"/>

Settings have been saved. Please [click here to restart](#) the router and bring the new settings into effect.

## MAC Filtering:

<b>Enable MAC Filtering</b>	Check the box to enable MAC filtering and select whether to “Deny” or “Allow” access for specified MAC address.
<b>Client PC MAC Address</b>	Enter a MAC address of computer or network device manually without dashes or colons e.g. for MAC address ‘aa-bb-cc-dd-ee-ff’ enter ‘aabbccddeeff’.
<b>Computer Name</b>	Select a computer name from the drop-down list and click “<<” to add its MAC address into the “Client PC Mac Address” field.  Click “Refresh’ in the drop-down menu to refresh the list of available MAC addresses. If the address you wish to add is not listed, enter it manually.
<b>Comment</b>	Enter a comment for reference/identification consisting of up to 16 alphanumerical characters.
<b>Add</b>	Click “Add” to add the MAC address to the MAC address filtering table.

MAC address entries will be listed in the table as shown below. Select an entry using the “Select” checkbox.

MAC Filtering Table :

NO	Computer Name	Client PC MAC Address	Comment	Select
1	MACBOOK-4729BA	00:1b:63:cb:4c:b5		<input type="checkbox"/>

Delete Selected Delete All

<b>Delete Selected / Delete All</b>	Delete selected or all entries from the table.
-------------------------------------	--

## IP Filtering:

<b>Enable IP Filtering</b>	Check the box to enable IP filtering and select whether to “Deny” or “Allow” access for specified IP address.
<b>Add PC</b>	Opens a new window to add a new IP to the list, to deny or allow access/services according to above.

### Access Control Add PC

This page allows users to define service limitations of client PCs, including IP address and service type.

#### Access Control Add PC :

Client PC Description   
Client PC IP address  -

#### Client PC Service :

Service Name	Detail Description	Select
WWW	HTTP, TCP Port 80, 3128, 8000, 8080, 8081	<input checked="" type="checkbox"/>
E-mail Sending	SMTP, TCP Port 25	<input checked="" type="checkbox"/>
News Forums	NNTP, TCP Port 119	<input checked="" type="checkbox"/>
E-mail Receiving	POP3, TCP Port 110	<input checked="" type="checkbox"/>
Secure HTTP	HTTPS, TCP Port 443	<input checked="" type="checkbox"/>
File Transfer	FTP, TCP Port 21, 20	<input checked="" type="checkbox"/>
MSN Messenger	TCP Port 1863	<input type="checkbox"/>
Telnet Service	TCP Port 23	<input type="checkbox"/>
AIM	AOL Instant Messenger, TCP Port 5190	<input type="checkbox"/>
NetMeeting	H.323, TCP Port 389,522,1503,1720,1731	<input type="checkbox"/>
DNS	UDP Port 53	<input type="checkbox"/>
SNMP	UDP Port 161, 162	<input type="checkbox"/>
VPN-PPTP	TCP Port 1723	<input type="checkbox"/>
VPN-L2TP	UDP Port 1701	<input type="checkbox"/>
TCP	All TCP Port	<input type="checkbox"/>
UDP	All UDP Port	<input type="checkbox"/>

#### User Define Service :

Protocol    
Port Range

<b>Client PC Description</b>	Enter a description for reference/identification of up to 16 alphanumeric characters.
<b>Client PC IP address</b>	Enter a starting IP address in the left field and the end IP address in the right field to define a range of IP addresses; or enter an IP address in the left field only to define a single IP address.
<b>Service Name</b>	Various services are listed here with a short description. Check/uncheck the box for each service you wish to select.
<b>Protocol</b>	Select protocol "TCP" or "UDP" or "Both" for a service not included in the "Client PC Service" list.
<b>Port Range</b>	Enter the port range for the service not included in the "Client PC Service" list.  Enter a single port number e.g. 110, a range of port numbers e.g. 110-120, or multiple port numbers separated by a comma e.g. 110,115,120.
<b>Add</b>	Click "Add" to add selected services or a user defined service to the IP filtering table.

IP filtering entries will be listed in the IP filtering table shown below.

Enable IP Filtering Table :  Deny  Allow

IP Filtering Table :

NO	Client PC Description	Client PC IP Address	Client Service	Protocol	Port Range	Select
1	Laptop	192.168.2.101	WWW, E-mail Sending, News Forums, E-mail Receiving, Secure HTTP, File Transfer			<input type="checkbox"/>

<b>Delete Selected/ Delete All</b>	Delete selected or all entries from the table.
--	--

### III-3-6-3. DMZ

A Demilitarized Zone (DMZ) is an isolated area in your local network where private IP addresses are mapped to specified Internet IP addresses, allowing unrestricted access to the private IP addresses but not to the wider local network.

You can define a virtual DMZ host here. This is useful for example, if a network client PC cannot run an application properly from behind an NAT firewall, since it opens the client up to unrestricted two-way access.

**DMZ**

Enable DMZ

Public	Client PC	Computer Name
<input checked="" type="radio"/> Dynamic IP <span>Session 1 ▾</span> <input type="text"/>	<input type="text"/>	<input type="button" value="&lt;&lt;"/> <span>----Select----</span> ▾
<input type="radio"/> Static IP <input type="text"/>		

Current DMZ Table :

NO	Computer Name	Public IP Address	Client PC IP Address	Select
				<input type="button" value="Delete Selected"/> <input type="button" value="Delete All"/>

<b>Enable DMZ</b>	Check/uncheck the box to enable/disable the device's DMZ function.
<b>Public</b>	Select "Dynamic IP" or "Static IP" here.  For "Dynamic IP" select an Internet connection session from dropdown menu.  For "Static IP" enter the IP address that you want to map to a specific private IP address.
<b>Client PC</b>	Enter the private IP address that the internet IP address will be mapped to.
<b>Computer Name</b>	Select a computer name from the list and click "<<" to enter its IP address into the "Client PC" field (above).
<b>Add</b>	Click "Add" to add the client to the "Current DMZ Table".

DMZ entries will be displayed in the table shown below:

Current DMZ Table :

NO	Computer Name	Public IP Address	Client PC IP Address	Select
----	---------------	-------------------	----------------------	--------

<b>Delete Selected/ Delete All</b>	Delete selected or all entries from the table.
--	--

### III-3-6-4. DoS

Denial-of-Service (DoS) is a common form of malicious attack against a network. The router's firewall can protect against such attacks.

If you are not familiar with these functions, it is recommended you keep the default settings.

**DoS**

Ping of Death      5      Ping of Death Packet(S) Per      Second      Burst      5

Discard Ping From WAN

Port Scan

- NMAP FIN / URG / PSH
- Xmas tree
- Another Xmas tree
- Null scan
- SYN / RST
- SYN / FIN
- SYN (only unreachable ports)

Sync Flood      30      Packet(S) Per      Second      Burst      30

<b>Ping of Death</b>	Specify the frequency of ping of death packets which will trigger the router's DoS protection function.
<b>Discard Ping from WAN</b>	Check this box and the router will not answer ping requests from the Internet.
<b>Port Scan</b>	Intruders use "port scanners" to detect open Internet IP address ports. Check each type of port scan to prevent.
<b>Sync Flood</b>	Specify the frequency of sync flood packets which will trigger the DoS protection function.



### III-3-7. QoS



Quality of Service (QoS) is a feature to manage Internet bandwidth efficiently. Some applications require more bandwidth than others to function properly, and QoS allows you to ensure that sufficient bandwidth is available. Minimum or maximum bandwidth can be guaranteed for a specified application.



***QoS can improve the BR-6428nS V3/BR-6228nS V3's performance. QoS is recommended to optimize performance for online gaming.***

#### III-3-7-1. QoS

Check/uncheck the box “Enable QoS” to enable/disable the QoS function. Click “Add” to open a new window and setup a QoS rule. The “Current QoS Table” displays all QoS rules.

**QoS**

Enable QoS

Total Download Bandwidth  kbits

Total Upload Bandwidth  kbits

Current QoS Table :

Priority	Rule Name	Upload Bandwidth	Download Bandwidth	Select
<div style="display: flex; justify-content: center; gap: 5px;"> <span style="background-color: #f4a460; padding: 2px 5px;">Add</span> <span style="background-color: #f4a460; padding: 2px 5px;">Edit</span> <span style="background-color: #f4a460; padding: 2px 5px;">Delete Selected</span> <span style="background-color: #f4a460; padding: 2px 5px;">Delete All</span> <span style="background-color: #f4a460; padding: 2px 5px;">Move Up</span> <span style="background-color: #f4a460; padding: 2px 5px;">Move Down</span> </div>				

Save Settings

<b>Total Download Bandwidth</b>	Enter your total download bandwidth limit from your Internet service provider (ISP) in kbits.
<b>Total Upload Bandwidth</b>	Enter your total upload bandwidth limit from your Internet service provider (ISP) in kbits.
<b>Add</b>	Opens a new window to add a new QoS rule to the current QoS table.

## QoS

This page allows users to add/modify the QoS rule's settings.

Rule Name

Bandwidth   kbits

Local IP Address  -

Local Port Range

Remote IP Address  -

Remote Port Range

Traffic Type

Protocol

<b>Rule Name</b>	Enter a name for the QoS rule for reference/identification.
<b>Bandwidth</b>	<p>Set the bandwidth limits for the QoS rule:</p> <div style="border: 1px solid black; padding: 5px; width: fit-content; margin: 0 auto;">             Bandwidth : <input type="button" value="Download"/> <input type="text"/> Kbps <input type="button" value="guarantee"/> </div> <p style="text-align: center;">(1)                      (2)                      (3)</p> <ol style="list-style-type: none"> <li>1. Select "Download" or "Upload" for the QoS rule.</li> <li>2. Enter the bandwidth limit.</li> <li>3. Select whether the bandwidth is a "Guarantee" (minimum) or "Max" (maximum).</li> </ol>
<b>Local IP Address</b>	<p>Enter the IP address range to which the QoS rule will be applied.</p> <p>Enter a starting IP address in the left field and the end IP address in the right field to define a range of IP addresses; or enter an IP address in the left field only to define a single IP address.</p>

<b>Local Port Range</b>	Enter the port range to activate the QoS rule. Enter a single port number e.g. 110 or a range of port numbers e.g. 110-120
<b>Remote IP Address</b>	Enter the remote IP address range which will activate the QoS rule. Enter a starting IP address in the left field and the end IP address in the right field to define a range of IP addresses; or enter an IP address in the left field only to define a single IP address.
<b>Remote Port Range</b>	Enter the remote port range to activate the QoS rule. Enter a single port number e.g. 110 or a range of port numbers e.g. 110-120
<b>Traffic Type</b>	Select traffic type as an alternative to specifying a port range above.
<b>Protocol</b>	Select a "TCP" or "UDP" protocol type.
<b>Save</b>	Click 'add' button to add a new QoS rule (detailed instructions will be given below).

QoS rule entries will be listed in the "Current QoS Table" as shown below. Select a rule using the "Select" checkbox.

 ***When using the "Edit" button only one rule can be selected each time.***

 ***QoS rules will be processed in the order that they are listed i.e. the rule at the top of the list will be applied first, and then the second rule etc. The order can be adjusted using the "Move Up/Down" buttons.***

Current QoS Table :

Priority	Rule Name	Upload Bandwidth	Download Bandwidth	Select
<span>Add</span> <span>Edit</span> <span>Delete Selected</span> <span>Delete All</span> <span>Move Up</span> <span>Move Down</span>				

<b>Edit</b>	Edit a selected rule.
<b>Delete Selected/ Delete All</b>	Delete selected or all entries from the table.
<b>Move Up/Down</b>	Move selected rule up or down the list.

### III-3-7-2. iQoS

iQoS is a more intuitive and automated tool to manage internet bandwidth than manually configuring the settings using QoS. For online gamers or users with bandwidth requirements for audio/video, iQoS is a useful function.



***iQoS cannot be used in conjunction with QoS and vice-versa. When one is enabled, the other is automatically disabled.***

click here to restart the router and bring the new settings into effect.'"/>

Check/uncheck the box “Enable iQoS” to enable/disable the iQoS function, and then enter your bandwidth limits and arrange the network application icons in priority order in the “Current iQoS Table”. Icons with higher priority will be assigned bandwidth more efficiently for better performance.

<b>Total Download Bandwidth</b>	Enter your total download bandwidth limit from your Internet service provider (ISP) in kbits.
<b>Total Upload Bandwidth</b>	Enter your total upload bandwidth limit from your Internet service provider (ISP) in kbits.

The icons represent the following categories:



Internet Browsing



P2P/BT Downloads



FTP



Multimedia



Online Gaming

The iQoS table is ordered left to right, high to low priority. Click a small icon below the table to insert it into the table, and click a large icon in the table to remove it. All spaces in the priority table must be filled.

### III-3-8. Advanced

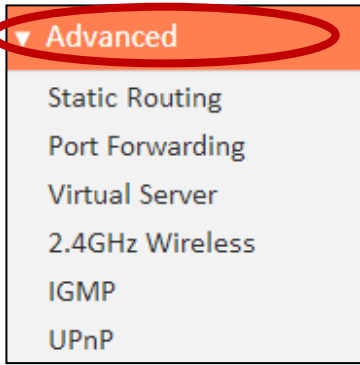

Advanced features of the BR-6428nS V3/BR-6228nS V3 can be configured from the “Advanced” menu.

#### III-3-8-1. Static Routing

Static routing is a method of configuring path selection of routers, characterized by the absence of communication between routers regarding the current topology of the network. The opposite of static routing is dynamic routing, sometimes also referred to as adaptive routing.

You can configure static routing and manually add routes to the routing table shown below.

**Static Routing**

Enable Static Routing

Destination LAN IP	Subnet Mask	Default Gateway	Hop Count	Interface
<input type="text"/>	<input type="text"/>	<input type="text"/>	<input type="text"/>	LAN <span style="font-size: small;">▼</span>
<b>Add</b>				

Current Static Routing Table :

NO	Destination LAN IP	Subnet Mask	Default Gateway	Hop Count	Interface	Select
<span style="margin-right: 20px;"><b>Delete Selected</b></span> <b>Delete All</b>						

**Save Settings**

<b>Enable Static Routing</b>	Check/uncheck the box to enable/disable static routing.
<b>Destination LAN IP</b>	Enter the destination network’s IP address.
<b>Subnet Mask</b>	Enter the subnet mask of the destination network.

<b>Default Gateway</b>	Enter the default gateway of the destination network.
<b>Hop Count</b>	Enter the hop count (the distance between destination network and this broadband router) here.
<b>Interface</b>	Enter the interface which leads to destination network.
<b>Add</b>	Add the route to the current static routing table.

Static Routing Table entries will be displayed in the table shown below:

Current Static Routing Table :

NO	Destination LAN IP	Subnet Mask	Default Gateway	Hop Count	Interface	Select
<input type="button" value="Delete Selected"/> <input type="button" value="Delete All"/>						

<b>Delete Selected/ Delete All</b>	Delete selected or all entries from the table.
--	--

### III-3-8-2. Port Forwarding

This function allows you to redirect a single port or consecutive ports of an Internet IP address to the same port of a local IP address. The port number(s) of the Internet IP address and local IP address must be the same.

If the port number of the Internet IP address and local IP address is different, please use the “Virtual Server” function instead.

**Port Forwarding**

Enable Port Forwarding

Private IP	Computer Name	Type	Port Range	Comment
<input type="text"/>	<input type="button" value="←"/> ----Select----	Both	<input type="text"/> - <input type="text"/>	<input type="text"/>
<input type="button" value="Add"/>				

Current Port Forwarding Table :

NO	Computer Name	Private IP	Type	Port Range	Comment	Select
<input type="button" value="Delete Selected"/> <input type="button" value="Delete All"/>						

<b>Private IP</b>	Enter the IP address of the computer on the local network.
<b>Computer Name</b>	Windows computers on the local network will be listed here – select a computer from the list and click << to automatically add the IP address to the “Private IP” field.
<b>Type</b>	Select the type of connection, “TCP”, “UDP” or “Both”.
<b>Port Range</b>	Input the starting port number in the left field, and input the ending port number in the right field. If you only want to redirect a single port number, only enter a port number in the left field.
<b>Comment</b>	Enter a comment for reference or identification.

Port Forwarding Table entries will be displayed in the table shown below:

Current Port Forwarding Table :						
NO	Computer Name	Private IP	Type	Port Range	Comment	Select
						<div style="display: flex; justify-content: flex-end; gap: 10px;"> <span>Delete Selected</span> <span>Delete All</span> </div>

<b>Delete Selected/ Delete All</b>	Delete selected or all entries from the table.
--	--



### III-3-8-3. Virtual Server

This function allows you to set up an internet service on a local computer, without exposing the local computer to the internet. You can also build various sets of port redirection, to provide various internet services on different local computers via a single internet IP address.

**Virtual Server**

Enable Virtual Server

Private IP	Computer Name	Private Port	Type	Public Port	Comment
<input type="text"/>	<input type="button" value="⏪"/> <span style="border: 1px solid #ccc; padding: 2px;">----Select----</span> <input type="button" value="▼"/>	<input type="text"/>	<span style="border: 1px solid #ccc; padding: 2px;">Both</span> <input type="button" value="▼"/>	<input type="text"/>	<input type="text"/>

Current Virtual Server Table :

NO	Computer Name	Private IP	Private Port	Type	Public Port	Comment	Select

<b>Private IP</b>	Specify the IP address of the computer on your local network.
<b>Computer Name</b>	Select the name of a Windows computer from the drop-down menu and click <input type="button" value="⏪"/> to auto-input its IP address in the "Private IP" field.
<b>Private Port</b>	Specify the private port you wish to use on the computer in your local network.
<b>Type</b>	Select the type of Internet Protocol.
<b>Public Port</b>	Specify a public port to access the computer on your local network.
<b>Comment</b>	Enter a comment for reference or identification.

Current Virtual Table entries will be displayed in the table shown below:

Current Virtual Server Table :

NO	Computer Name	Private IP	Private Port	Type	Public Port	Comment	Select

**Delete Selected/  
Delete All**

Delete selected or all entries from the table.

### III-3-8-4. 2.4GHz Wireless

These settings are for experienced users only. Please do not change any of the values on this page unless you are already familiar with these functions.

**2.4GHz Wireless**

Wireless Module  Enable

Fragment Threshold  (256-2346)

RTS Threshold  (0-2347)

Beacon Interval  (20-1024 ms)

DTIM Period  (1-10)

Data Rate  ▾

N Data Rate  ▾

Channel Width  Auto 20/40 MHz  20 MHz

Preamble Type  Short Preamble  Long Preamble

CTS Protect  Auto  Always  None

Tx Power  ▾

WMM  Auto

<b>Fragment Threshold</b>	Set the Fragment threshold of the wireless radio. The default value is 2346.
<b>RTS Threshold</b>	Set the RTS threshold of the wireless radio. The default value is 2347.
<b>Beacon Interval</b>	Set the beacon interval of the wireless radio. The default value is 100.
<b>DTIM Period</b>	Set the DTIM period of wireless radio. The default value is 3.
<b>Data Rate</b>	Set the wireless data transfer rate. The default is set to Auto.
<b>N Data Rate</b>	Set the data rate of 802.11n. The default is set to Auto.

<b>Channel Width</b>	Select wireless channel width (bandwidth used by wireless signals from the device) – the recommended value is Auto 20/40MHz.
<b>Preamble Type</b>	Set the wireless radio preamble type. The default value is “Short Preamble”.
<b>CTS Protect</b>	Enabling this setting will reduce the chance of radio signal collisions between 802.11b and 802.11g wireless access points. It’s recommended to set this option to “Auto”.
<b>Tx Power</b>	Set the power output of the wireless radio. You may not require 100% output power. Setting a lower power output can enhance security since potentially malicious/unknown users in distant areas will not be able to access your signal.
<b>WMM</b>	WMM (Wi-Fi Multimedia) technology can improve the performance of certain network applications, such as audio/video streaming, network telephony (VoIP) and others. When WMM is enabled, the device will prioritize different kinds of data and give higher priority to applications which require instant responses for better performance.

### III-3-8-5. IGMP

IGMP is a communications protocol used to establish multicast group memberships. It allows for a more efficient use of resources and better performance for applications such as IPTV video streaming.

IGMP

IGMP Snooping  Enable  Disable

IGMP Proxy  Enable  Disable

Save Settings

<b>IGMP Snooping</b>	IGMP snooping monitors traffic between hosts and multicast routers to facilitate bandwidth conservation. Select enable or disable.
<b>IGMP Proxy</b>	IGMP proxy enables intelligent multicast forwarding based on IGMP snooping information. Select enable or disable.



***It is recommended to set “IGMP Snooping” and “IGMP Proxy” to “Enable”.***

### III-3-8-6. UPnP

Universal plug-and-play (UPnP) is a set of networking protocols which enables network devices to communicate and automatically establish working configurations with each other. Select “Enable” or “Disable”.

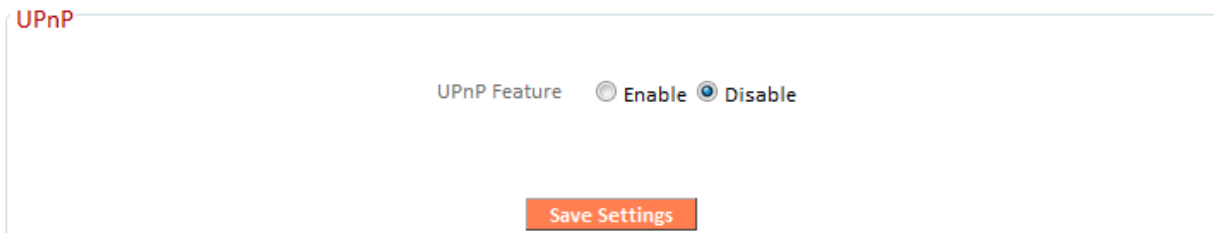

UPnP

UPnP Feature  Enable  Disable

Save Settings

The image shows a configuration window for UPnP. The title is "UPnP" in red. Below the title, there is a label "UPnP Feature" followed by two radio buttons: "Enable" and "Disable". The "Disable" radio button is selected. At the bottom center of the window, there is an orange button labeled "Save Settings".

### III-3-9. Administration

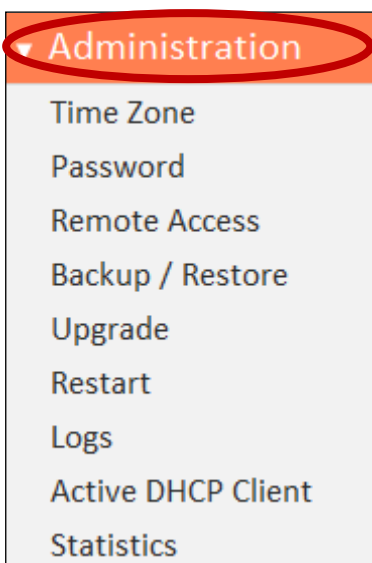

Various administrative functions can be accessed from the “Administration” menu.

#### III-3-9-1. Time Zone

**Time Zone**

Set Time Zone: (GMT)Greenwich Mean Time: Dublin, Edinburgh, Lisbon, London

Time Server Address: pool.ntp.org

Daylight Savings:  Enable Function  
January 1 To January 1

Save Settings

<b>Set Time Zone</b>	Select the time zone of your country or region.
<b>Time Server Address</b>	The travel router supports NTP (Network Time Protocol) for automatic time and date setup. Input the host name of the IP server manually.
<b>Daylight Saving</b>	If your country/region uses daylight saving time, please check the “Enable Function” box, and select the start and end date.

### III-3-9-2. Password

You can change the password used to login to the browser-based configuration interface here. It is advised to do so for security purposes.



***Please make a note of the new password. In the event that you forget the password and are unable to login to the browser based configuration interface, see [II-7. Reset to factory default settings](#) for how to reset the device.***

Password

Current Password

New Password

Confirmed Password

<b>Current Password</b>	Enter your current password.
<b>New Password</b>	Enter your new password.
<b>Confirmed Password</b>	Confirm your new password.

### III-3-9-3. Remote Access

Check “Enabled” to enable the remote access feature and then enter the appropriate values.

Remote Access

Host IP Address

Port

Enabled

[Save Settings](#)

<b>Host IP Address</b>	Specify the IP address which is allowed remote access.
<b>Port</b>	Specify a port number (0–65535) used for remote access.



### III-3-9-4. Backup/Restore

Backup / Restore

Backup Settings

Restore Settings

Restore to Factory Default

<b>Backup Settings</b>	Click "Save" to save the current settings on your computer as config.bin file.
<b>Restore Settings</b>	Click "Browse" to find a previously saved config.bin file and then click "Upload" to replace your current settings.
<b>Restore to Factory Default</b>	Click "Reset" to restore settings to the factory default. A pop-up window will appear and ask you to confirm and enter your log in details. Enter your username and password and click "Ok". See below for more information.

### III-3-9-5. Upgrade

The upgrade page allows you to upgrade the system firmware to a more recent version. You can download the latest firmware from the Edimax website. After the upgrade, the system will restart.



***Do not switch off or disconnect the device during a firmware upgrade, as this could damage the device. It is recommended that you use a wired Ethernet connection for a firmware upgrade.***

Upgrade

### III-3-9-6. Restart

In the event that the router malfunctions or is not responding, then it is recommended that you restart the device.

**Restart**

In the event that the system stops responding correctly or stops functioning, you can perform a system restart. Your settings will not be changed. To restart, click on the APPLY button below. You will be asked to confirm your decision. The restart will be complete when the Internet LED light stops blinking.

**Apply**

### III-3-9-7. Logs

You can view the system log and security log here. Use the drop down menu in the top-right corner to select which log to view.

**System Log**

System Log

```
Jan 1 00:00:08 (none) syslog.info syslogd started: BusyBox v1.11.1
Mar 13 07:34:44 (none) user.debug syslog: Debu: buildfVc: Interface lo Addr: 127.0.0.1, Flags: 0x
Mar 13 07:34:44 (none) user.debug syslog: Debu: buildfVc: Interface eth1 Addr: 192.168.10.143,
Mar 13 07:34:44 (none) user.debug syslog: Debu: buildfVc: Interface br0 Addr: 192.168.2.1, Flag
Mar 13 07:34:44 (none) user.notice syslog: Note: adding VIF, idx=0 FI flags=0x0 IP=192.168.2.1 b
Mar 13 07:34:44 (none) user.notice syslog: Note: adding VIF, idx=1 FI flags=0x0 IP=192.168.10.14
```

**Save** **Clear** **Refresh**

**Security Log**

Security Log

```
[1970-01-01 00:00:22]: start Dynamic IP
[1970-01-01 00:00:24]: [SNTP]: connect to TimeServer 59.124.196.84 ...
[2014-03-13 07:34:33]: [SNTP]: connect success!
[2014-03-13 07:34:33]: [SNTP]: set time to 2014-03-13 07:34:33
[2014-03-13 07:34:34]: [Firewall]: WAN1 IP is 192.168.10.143
[2014-03-13 07:34:34]: [Firewall]: WAN2 IP is 0.0.0.0
[2014-03-13 07:34:34]: [Firewall]: WAN3 IP is 0.0.0.0
[2014-03-13 07:34:34]: [Firewall]: setting firewall...
[2014-03-13 07:34:36]: [SNTP]: connect to TimeServer 59.124.196.84 ...
```

**Save** **Clear** **Refresh**

<b>Save</b>	Click “Save” to save the log on your computer as .txt file.
<b>Clear</b>	Click “Clear” to clear/erase the existing log.
<b>Refresh</b>	Click “Refresh” to refresh the log and update any activity.

### III-3-9-8. Active DHCP Client

Information about active DHCP clients is shown in the table, which displays the DHCP server assigned IP address, MAC address and time expired for each computer or device on the local network.

Active DHCP Client

IP Address	MAC Address	Time Expired (Sec)
192.168.2.101	00:1b:63:cb:4c:b5	forever

[Refresh](#)

### III-3-9-9. Statistics

Displays sent and received packet network statistics.

Statistics

2.4GHz Wireless	Sent Packets	1745
	Received Packets	30311
5GHz Wireless	Sent Packets	517
	Received Packets	56878
Ethernet LAN	Sent Packets	1494
	Received Packets	1868
Ethernet WAN	Sent Packets	1624
	Received Packets	5075

[Refresh](#)

## IV. Appendix

---

### IV-1. Configuring your IP address

For first time access to the URL ***http://Edimax.Setup*** please ensure your computer is set to use a dynamic IP address. This means your computer can obtain an IP address automatically from a DHCP server. You can check if your computer is set to use a dynamic IP address by following [IV-1-1. How to check that your computer uses a dynamic IP address.](#)

**Static IP users** can also temporarily modify your computer's IP address to be in the same IP address subnet e.g. **192.168.2.x (x = 3 – 254)** as the BR-6428nS V3/BR-6228nS V3 in order to access ***http://Edimax.Setup***.



***The BR-6428nS V3/BR-6228nS V3's default IP address is 192.168.2.1.***

The procedure for modifying your IP address varies across different operating systems; please follow the guide appropriate for your operating system in [IV-1-2. How to modify the IP address of your computer.](#)



***Static IP users please make a note of your static IP before you change it.***

You can assign a new IP address to the device which is within the subnet of your network during setup or using the browser based configuration interface (refer to [III-3-4. LAN](#)). Then you can access the URL ***http://Edimax.Setup*** in future without modifying your IP address.



***Please remember to change your IP address back to its original value after the device is properly configured.***

## IV-1-1. How to check that your computer uses a dynamic IP address

Please follow the instructions appropriate for your operating system.

### IV-1-1-1. Windows XP

1. Click the “Start” button (it should be located in the lower-left corner of your computer), then click “Control Panel”. Double-click the “Network and Internet Connections” icon, click “Network Connections”, and then double-click “Local Area Connection”. The “Local Area Connection Status” window will then appear, click “Properties”.

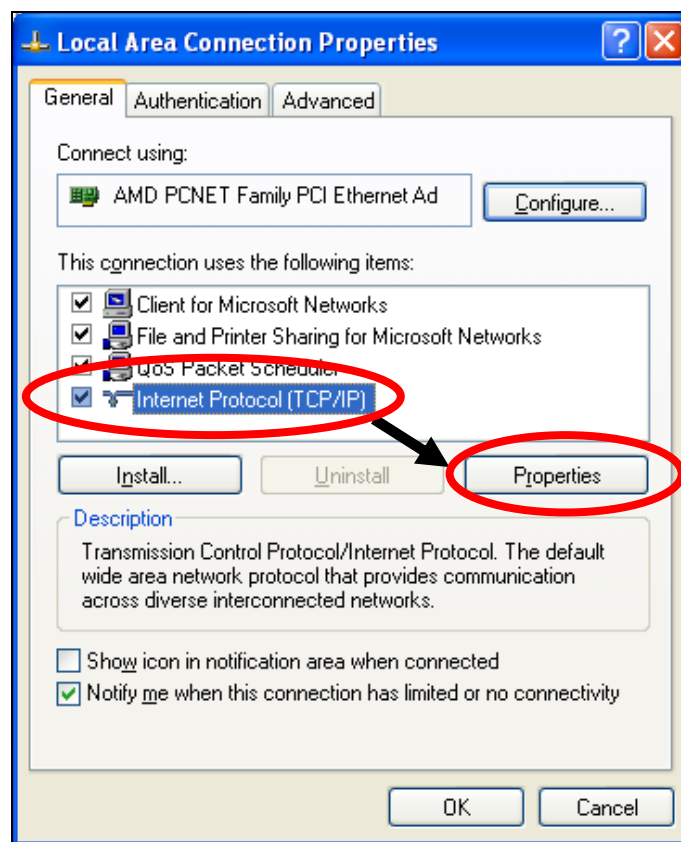

2. “Obtain an IP address automatically” and “Obtain DNS server address automatically” should be selected.

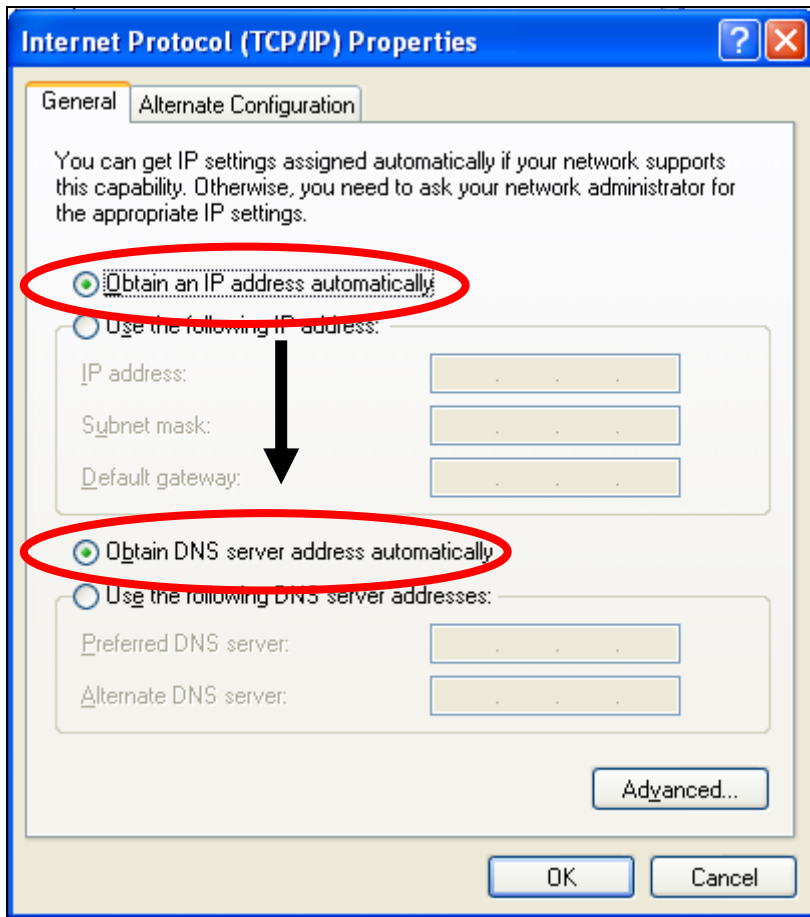

## IV-1-1-2. Windows Vista

1. Click the “Start” button (it should be located in the lower-left corner of your computer), then click “Control Panel”. Click “View Network Status and Tasks”, then click “Manage Network Connections”. Right-click “Local Area Network”, then select “Properties”. The “Local Area Connection Properties” window will then appear, select “Internet Protocol Version 4 (TCP / IPv4)”, and then click “Properties”.

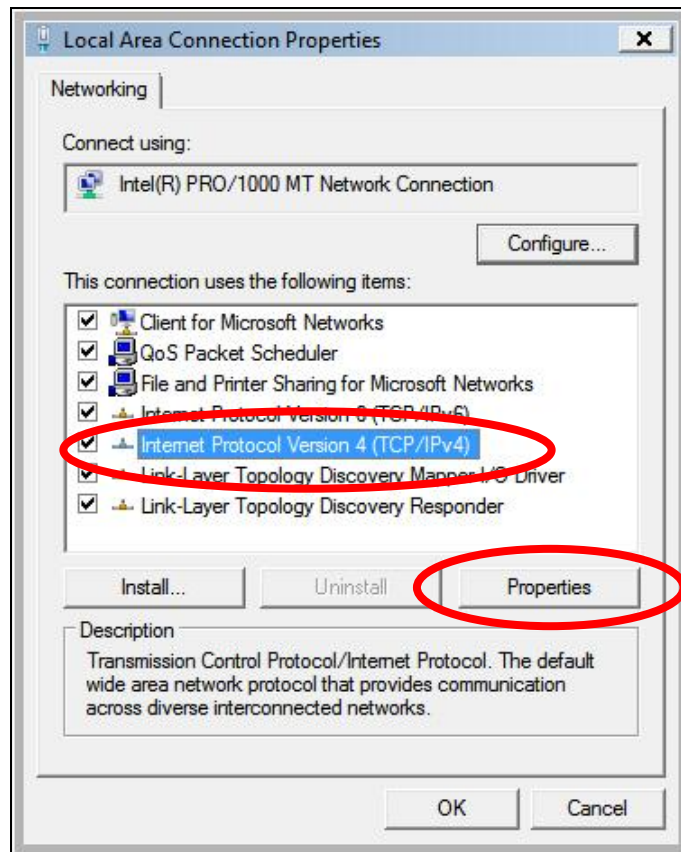

2. Select “Obtain an IP address automatically” and “Obtain DNS server address automatically” should be selected.

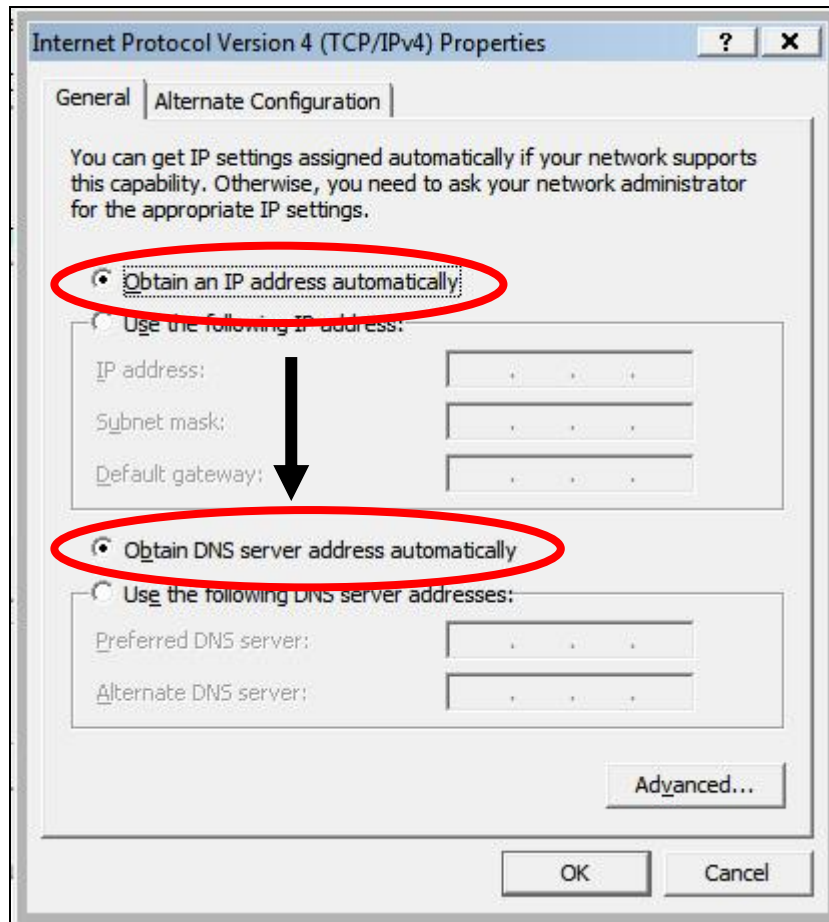



### IV-1-1-3. Windows 7

1. Click the “Start” button (it should be located in the lower-left corner of your computer), then click “Control Panel”.

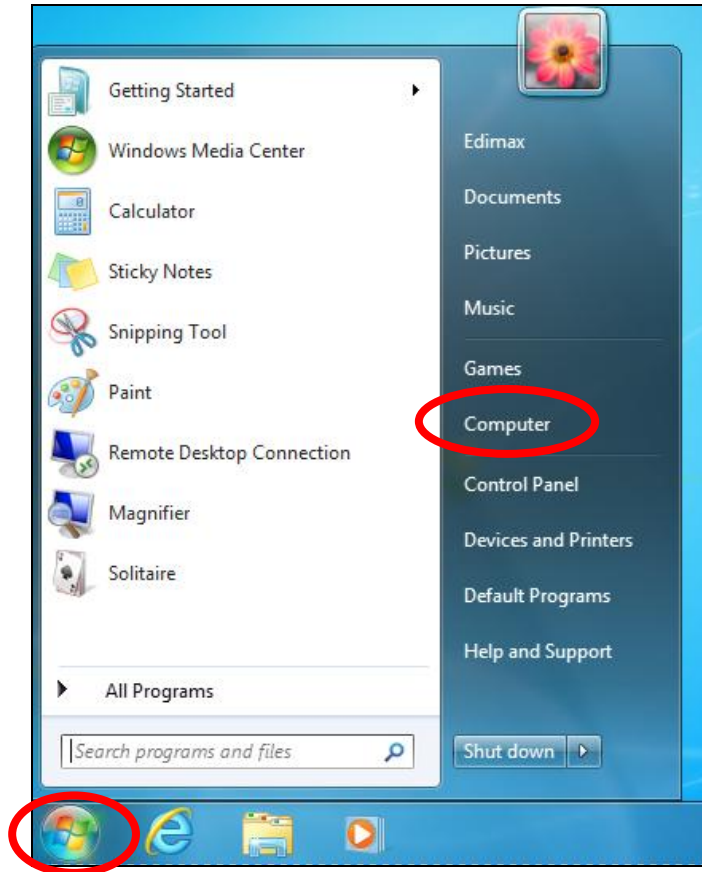

2. Under “Network and Internet” click “View network status and tasks”.

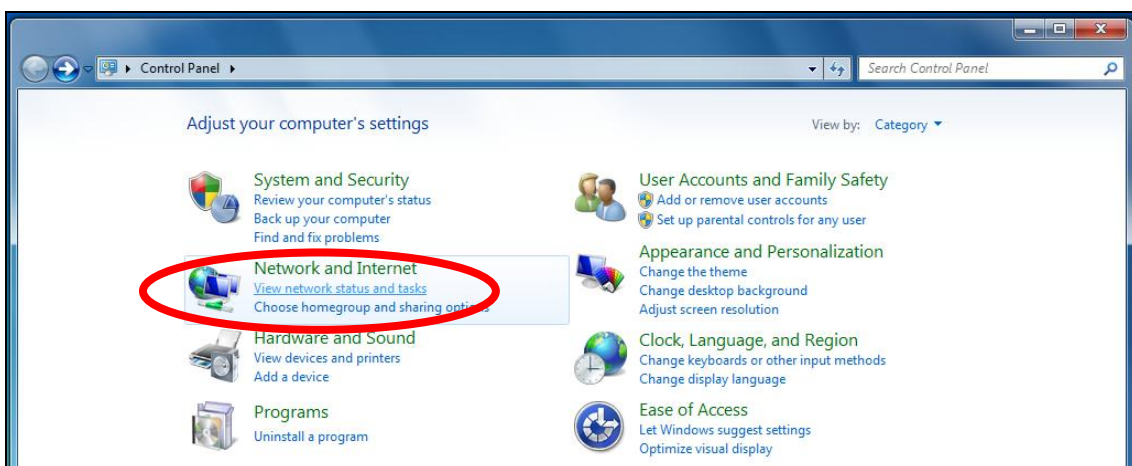

3. Click “Local Area Connection”.

View your basic network information and set up connections

TS-WIN7 (This computer) — Home network — ~~Internet~~ [See full map](#)

View your active networks [Connect or disconnect](#)

**Home network**  
Home network

Access type: No Internet access  
HomeGroup: [Ready to create](#)  
Connections: [Local Area Connection](#)

4. Click “Properties”.

Local Area Connection Status

General

Connection

IPv4 Connectivity:	No Internet access
IPv6 Connectivity:	No network access
Media State:	Enabled
Duration:	02:08:52
Speed:	100.0 Mbps

[Details...](#)

Activity

	Sent	Received
Bytes:	951,332	4,398,184

[Properties](#) [Disable](#) [Diagnose](#)

[Close](#)

5. Select “Internet Protocol Version 4 (TCP/IPv4) and then click “Properties”.

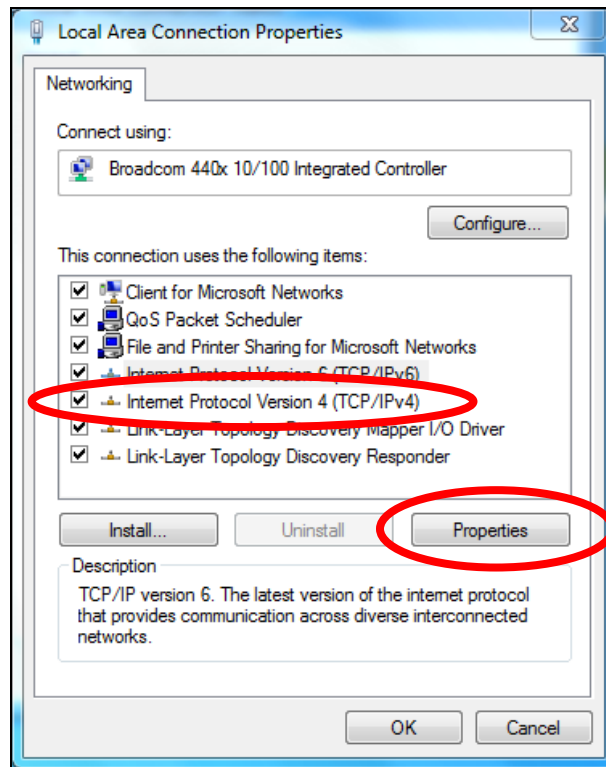

6. Select “Obtain an IP address automatically” and “Obtain DNS server address automatically” should be selected.

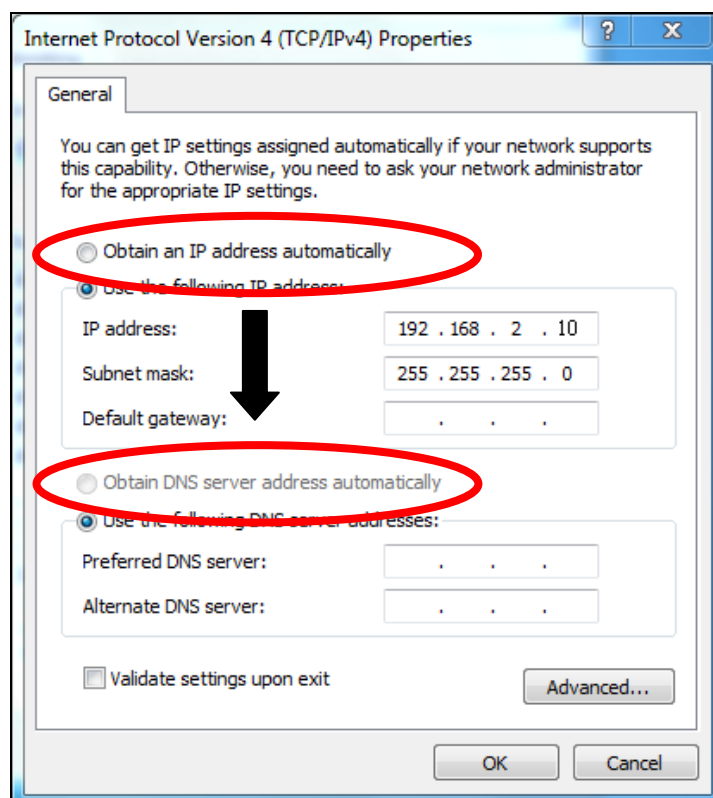

#### IV-1-1-4. Windows 8

1. From the Windows 8 Start screen, you need to switch to desktop mode. Move your cursor to the bottom left of the screen and click.

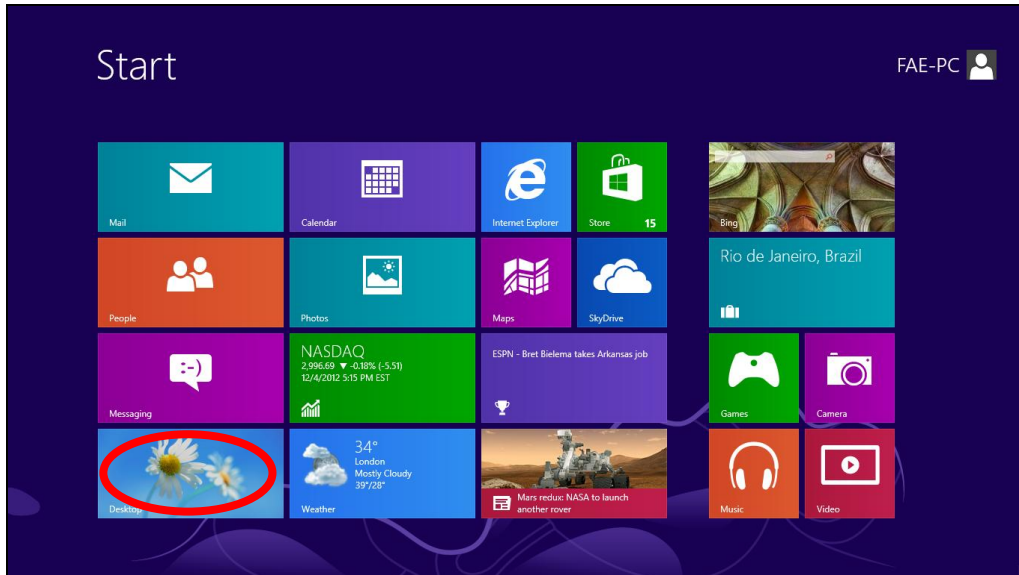

2. In desktop mode, click the File Explorer icon in the bottom left of the screen, as shown below.

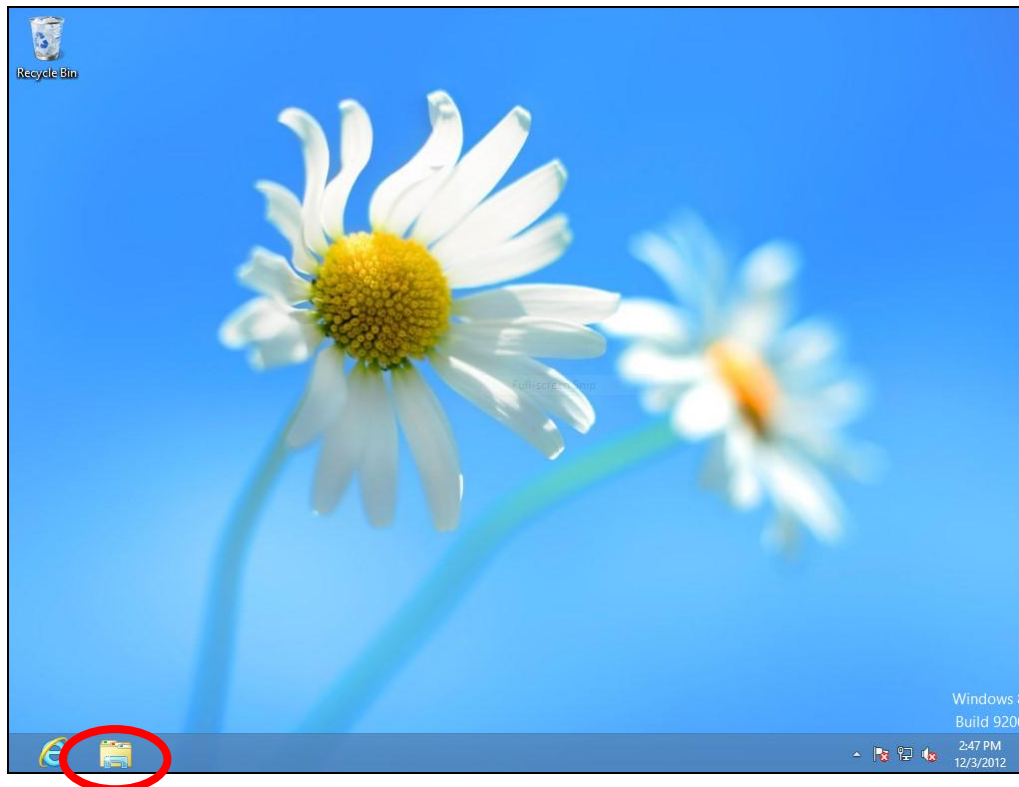

3. Right click "Network" and then select "Properties".

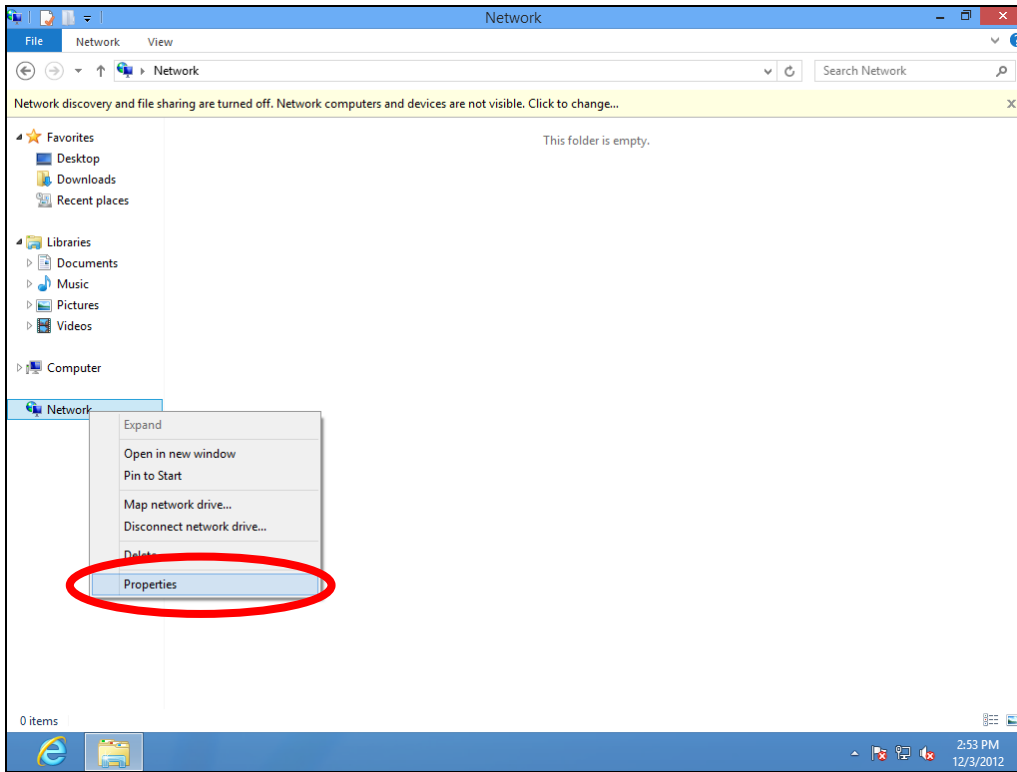

4. In the window that opens, select “Change adapter settings” from the left side.

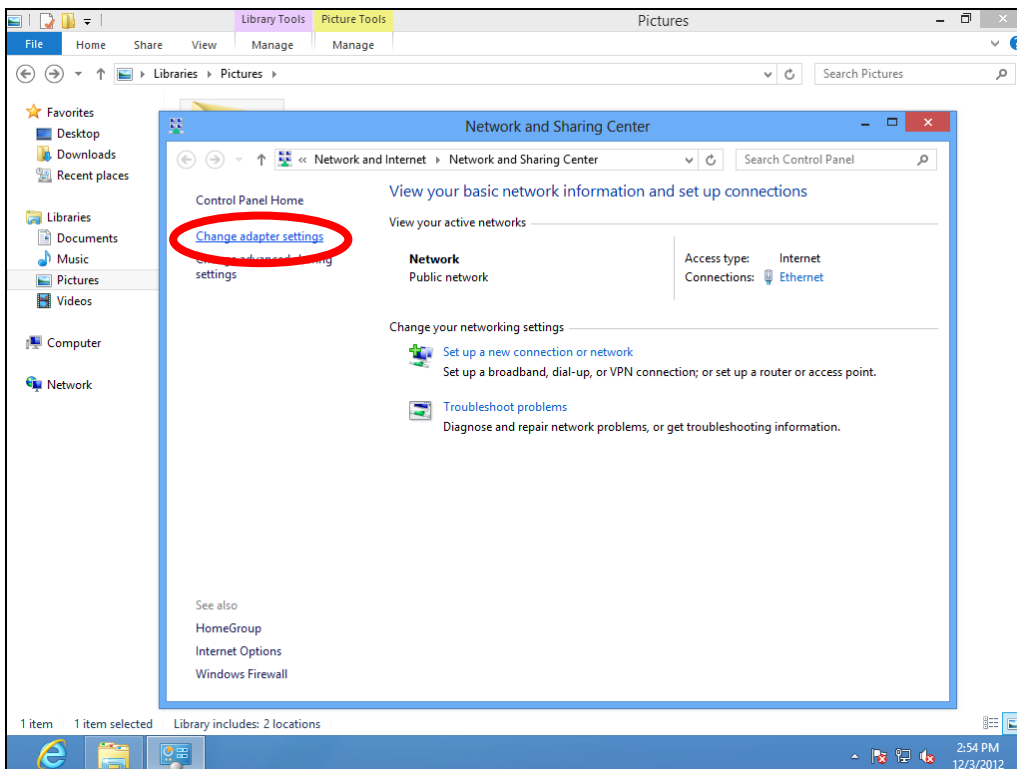

5. Choose your connection and right click, then select “Properties”.

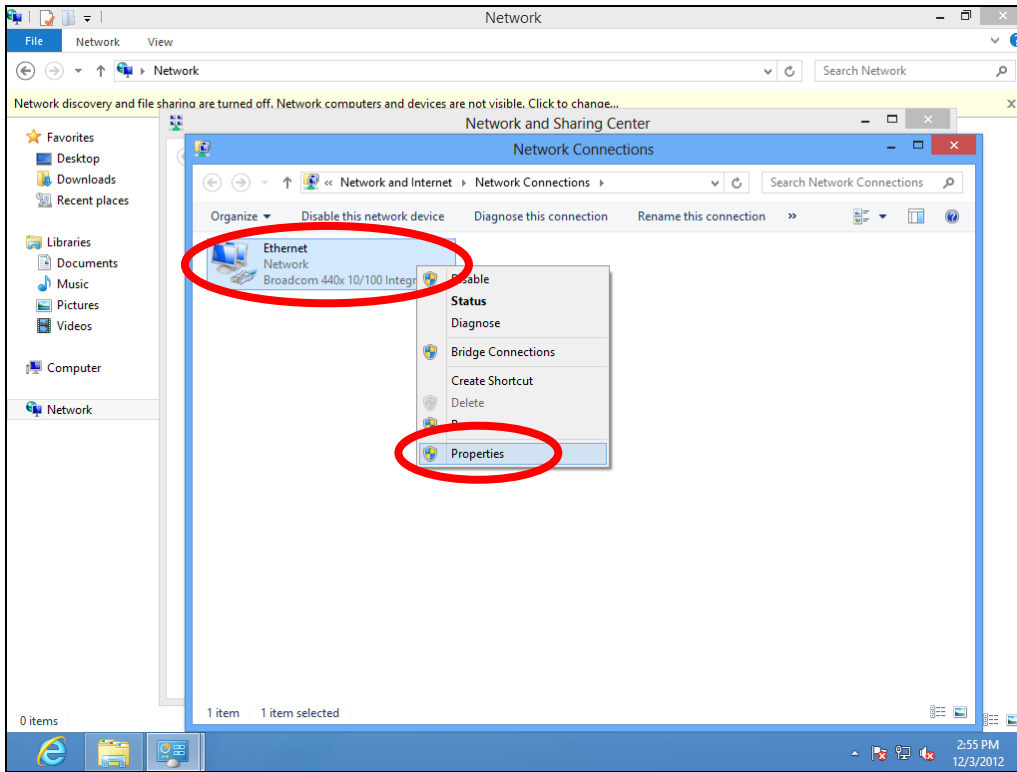

6. Select “Internet Protocol Version 4 (TCP/IPv4) and then click “Properties”.

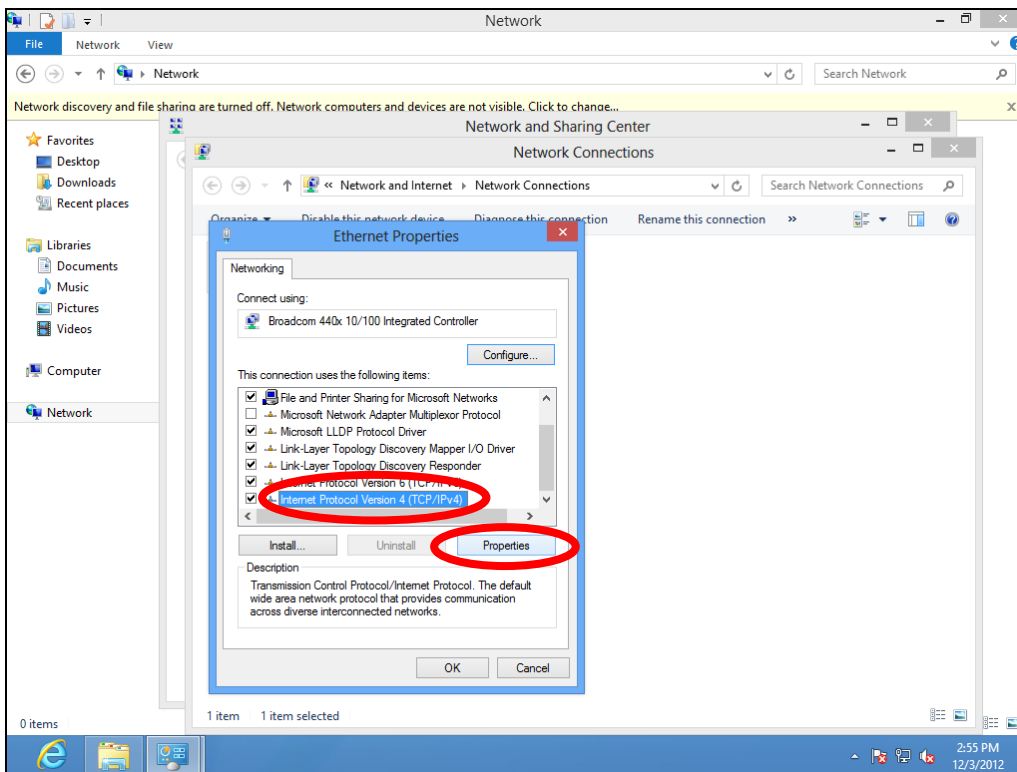

7. Select “Obtain an IP address automatically” and “Obtain DNS server address automatically” should be selected.

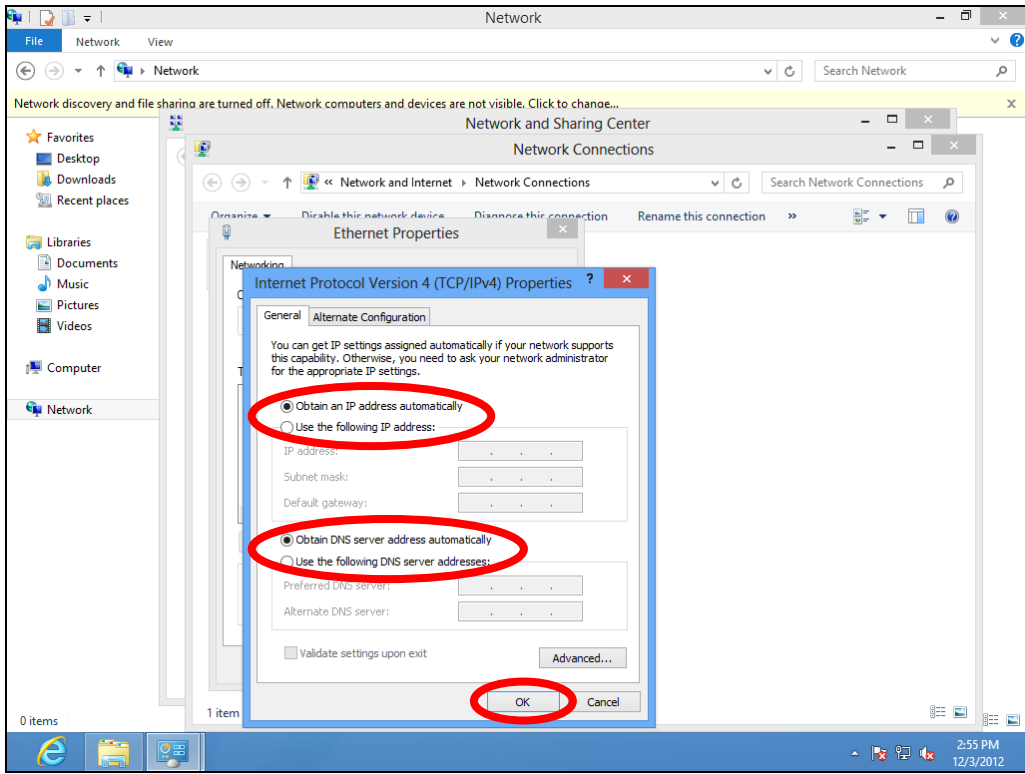

## IV-1-1-5. Mac OS

1. Have your Macintosh computer operate as usual, and click on “System Preferences”.

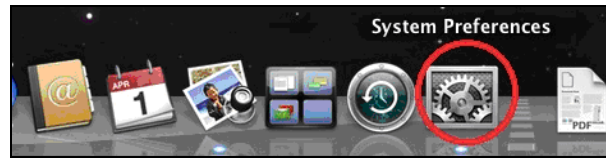

2. In System Preferences, click on “Network”.

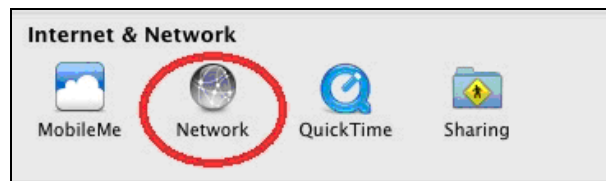

3. Click on “Wi-Fi” in the left panel and then click “Advanced” in the lower right corner.

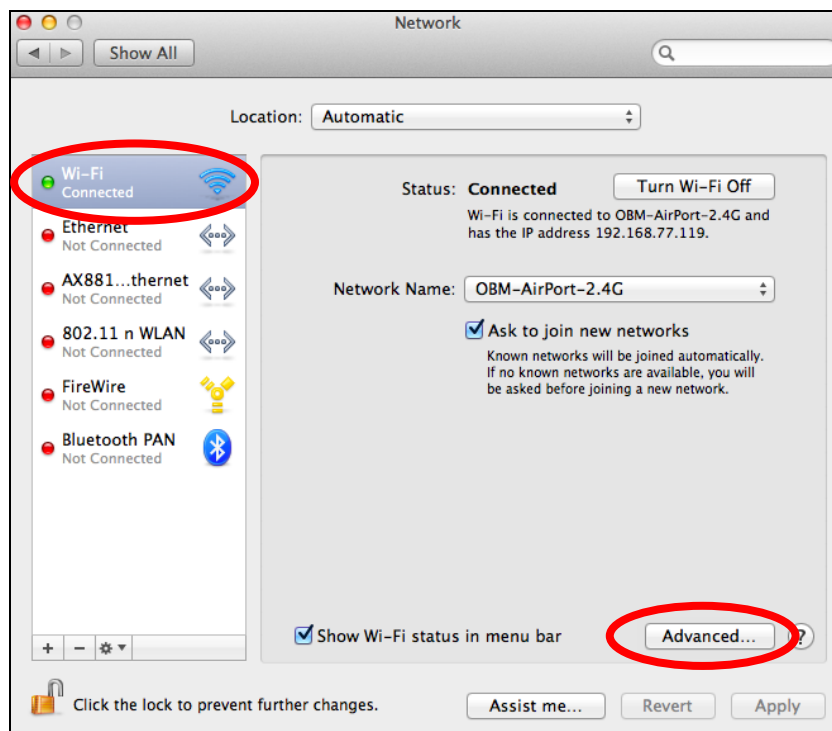

4. Select “TCP/IP” from the top menu and “Using DHCP” in the drop down menu labeled “Configure IPv4” should be selected.



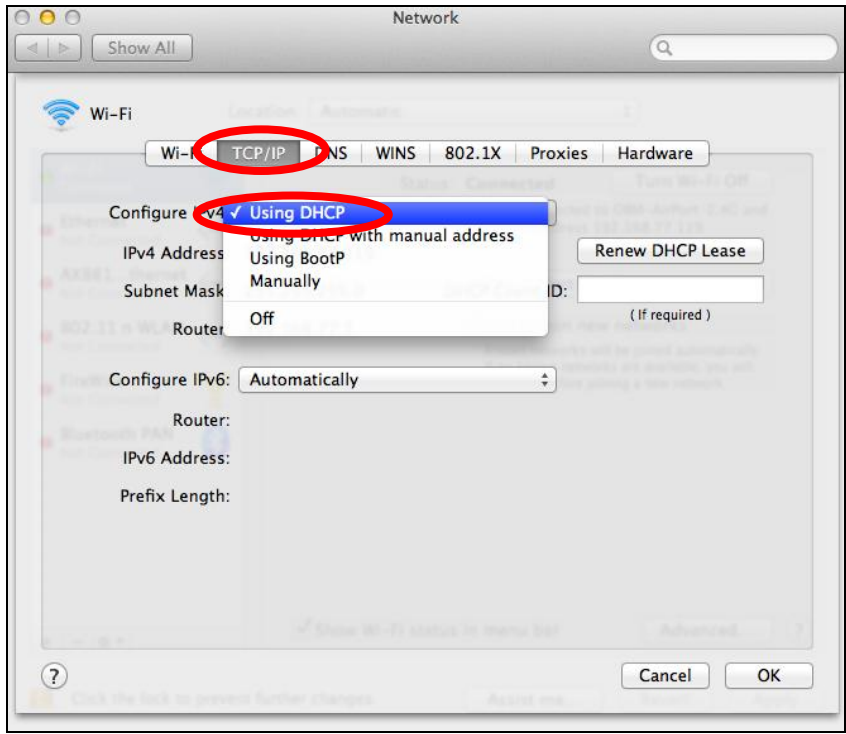

## IV-1-2. How to modify the IP address of your computer

Please follow the instructions appropriate for your operating system. In the following examples we use the IP address **192.168.2.10** though you can use any IP address in the range **192.168.2.x (x = 3 – 254)** in order to access iQ Setup/browser based configuration interface.

 **Please make a note of your static IP before you change it.**

### IV-1-2-1. Windows XP

1. Click the “Start” button (it should be located in the lower-left corner of your computer), then click “Control Panel”. Double-click the “Network and Internet Connections” icon, click “Network Connections”, and then double-click “Local Area Connection”. The “Local Area Connection Status” window will then appear, click “Properties”.

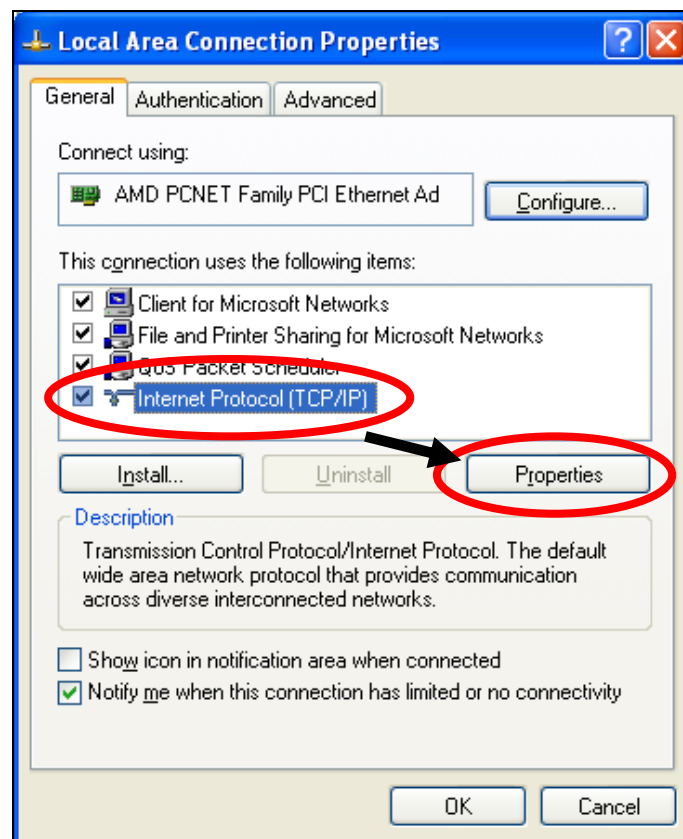

2. Select “Use the following IP address” and “Use the following DNS server addresses”, then input the following values:



***Your existing static IP address will be displayed in the “IP address” field before you replace it. Please make a note of this IP address, subnet mask, default gateway and DNS server addresses.***

**IP address:** 192.168.2.10

**Subnet Mask:** 255.255.255.0

**Preferred DNS Server:** 192.168.2.1

Click 'OK' when finished.

## IV-1-2-2. Windows Vista

1. Click the “Start” button (it should be located in the lower-left corner of your computer), then click “Control Panel”. Click “View Network Status and Tasks”, then click “Manage Network Connections”. Right-click “Local Area Network”, then select “Properties”. The “Local Area Connection Properties” window will then appear, select “Internet Protocol Version 4 (TCP / IPv4)”, and then click “Properties”.

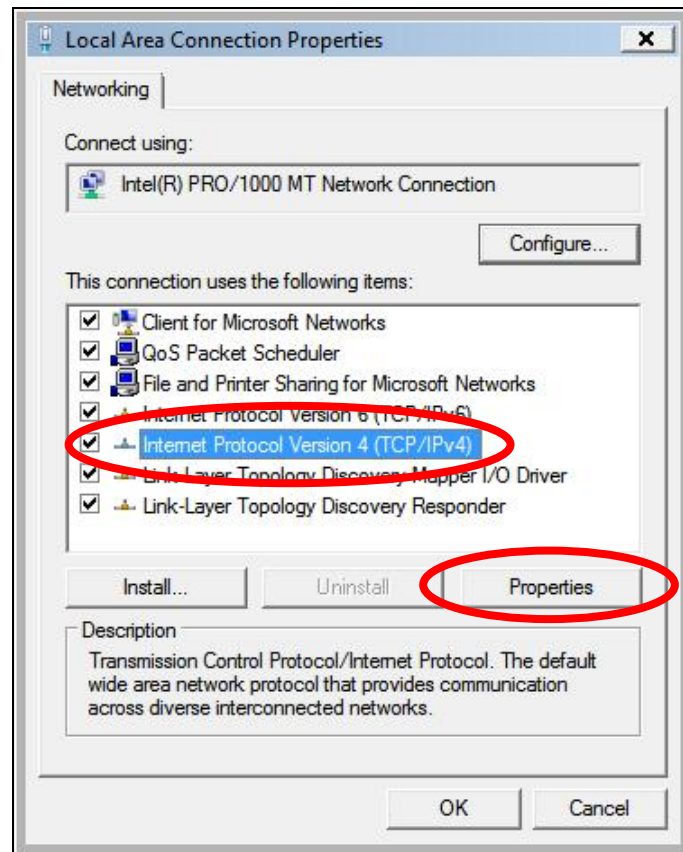

2. Select “Use the following IP address” and “Use the following DNS server addresses”, then input the following values:

 ***Your existing static IP address will be displayed in the “IP address” field before you replace it. Please make a note of this IP address, subnet mask, default gateway and DNS server addresses.***

**IP address:** 192.168.2.10

**Subnet Mask:** 255.255.255.0

**Preferred DNS Server:** 192.168.2.1

Click ‘OK’ when finished.

### IV-1-2-3. Windows 7

1. Click the “Start” button (it should be located in the lower-left corner of your computer), then click “Control Panel”.

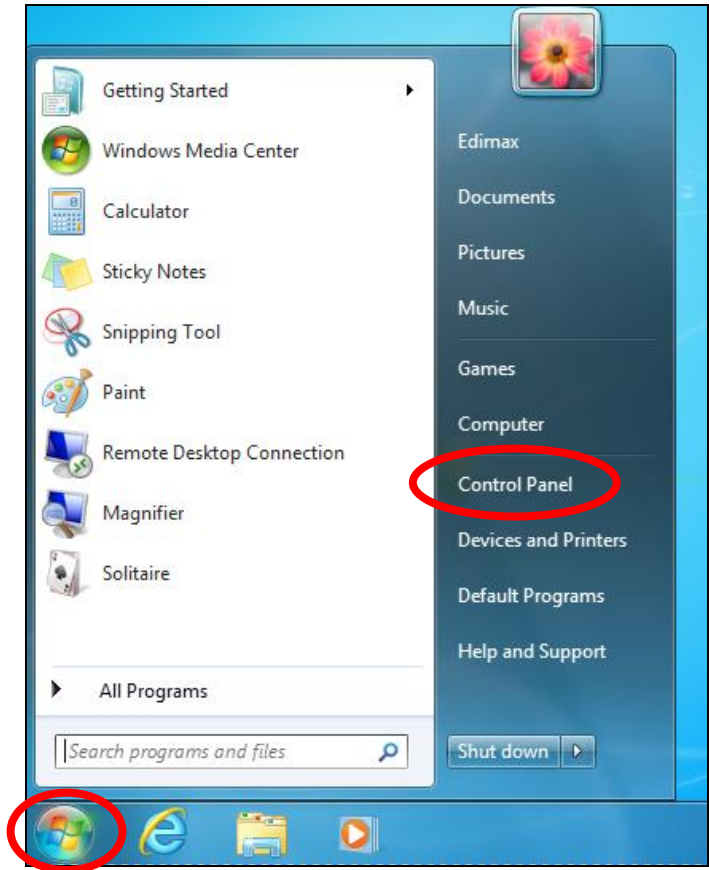

2. Under “Network and Internet” click “View network status and tasks”.

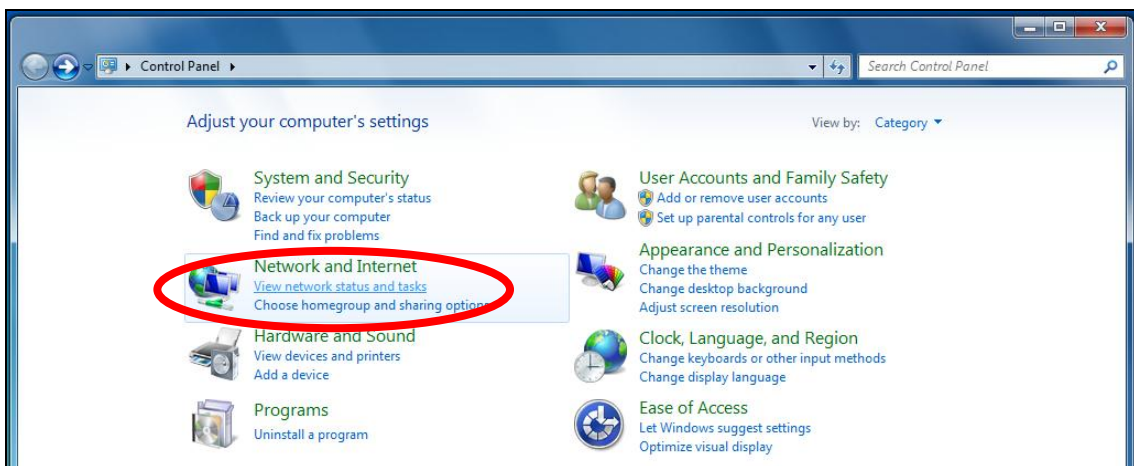

3. Click “Local Area Connection”.

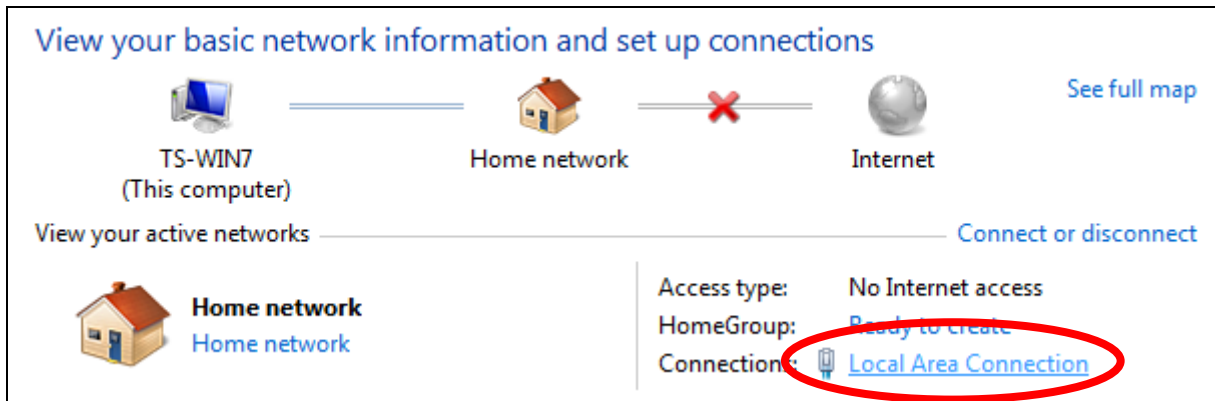

4. Click “Properties”.

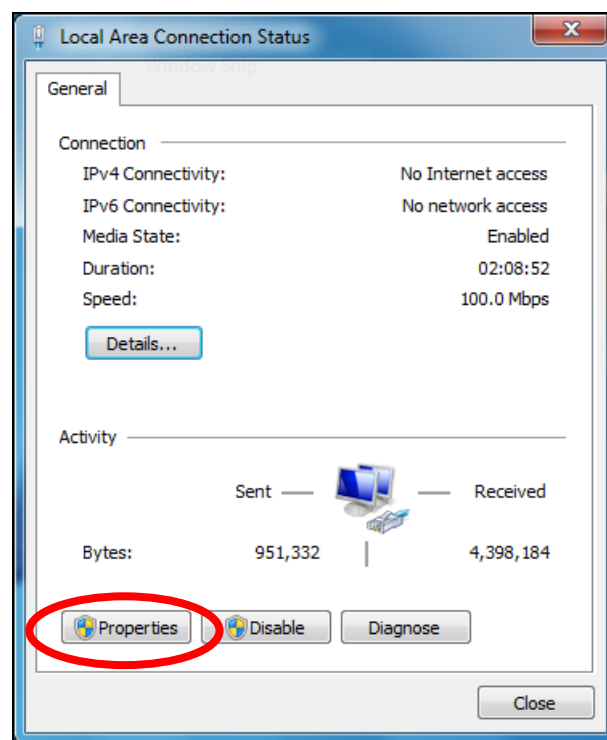

5. Select “Internet Protocol Version 4 (TCP/IPv4) and then click “Properties”.

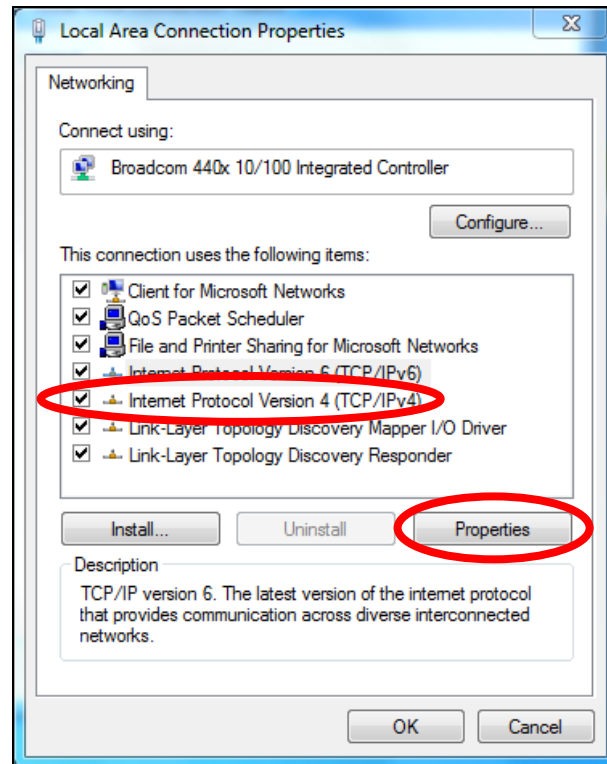

6. Select “Use the following IP address” and “Use the following DNS server addresses”, then input the following values:



***Your existing static IP address will be displayed in the “IP address” field before you replace it. Please make a note of this IP address, subnet mask, default gateway and DNS server addresses.***

**IP address:** 192.168.2.10

**Subnet Mask:** 255.255.255.0

**Preferred DNS Server:** 192.168.2.1

Click ‘OK’ when finished.

## IV-1-2-4. Windows 8

1. From the Windows 8 Start screen, you need to switch to desktop mode. Move your cursor to the bottom left of the screen and click.

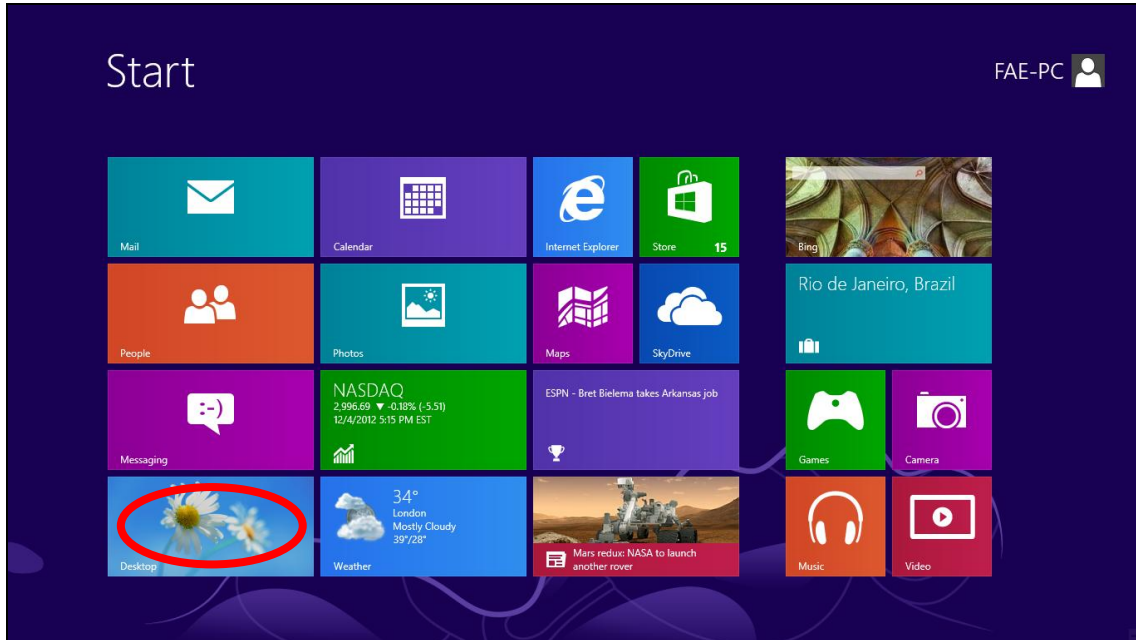

2. In desktop mode, click the File Explorer icon in the bottom left of the screen, as shown below.

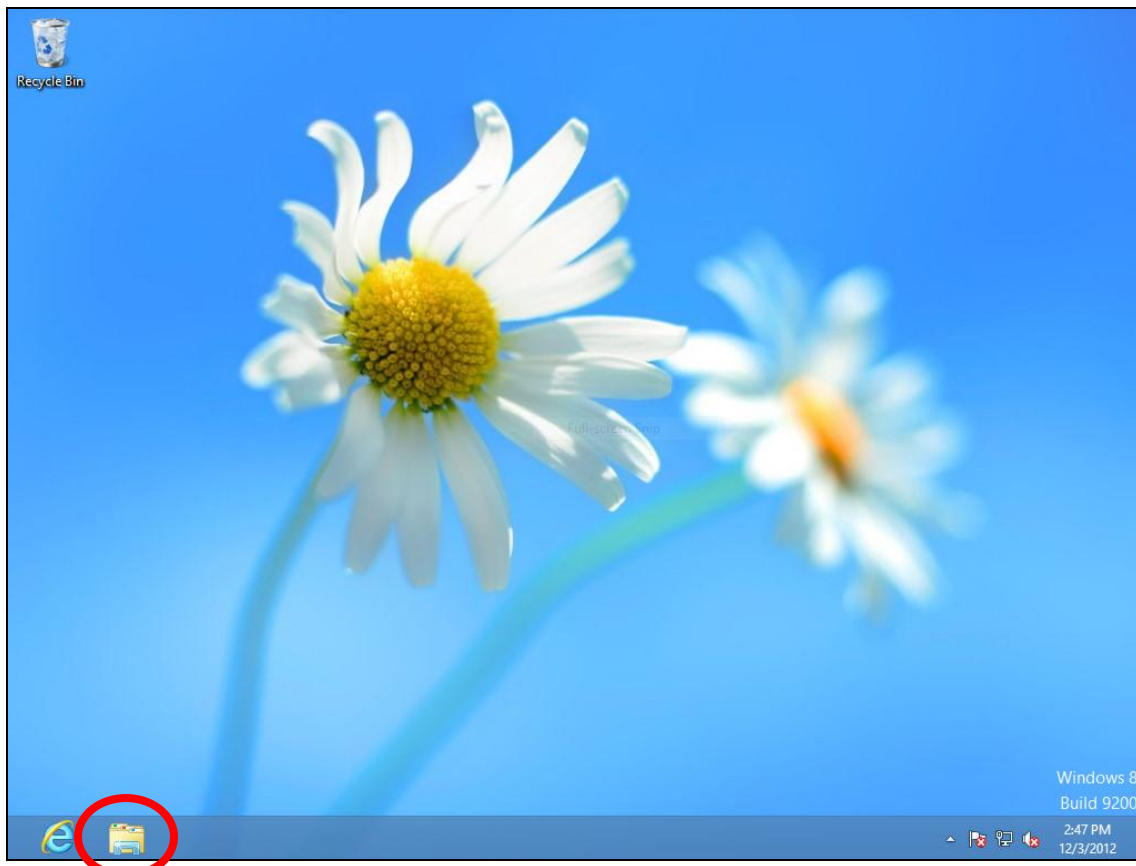



3. Right click “Network” and then select “Properties”.

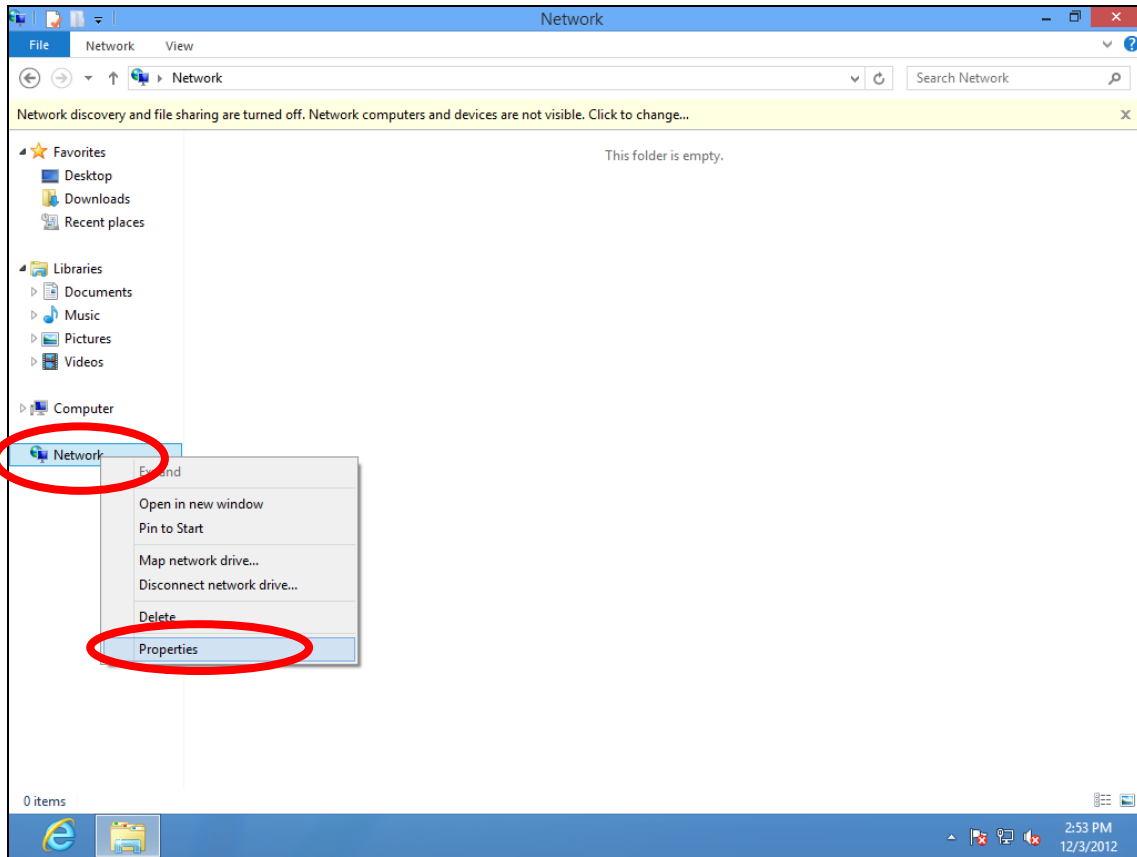

4. In the window that opens, select “Change adapter settings” from the left side.

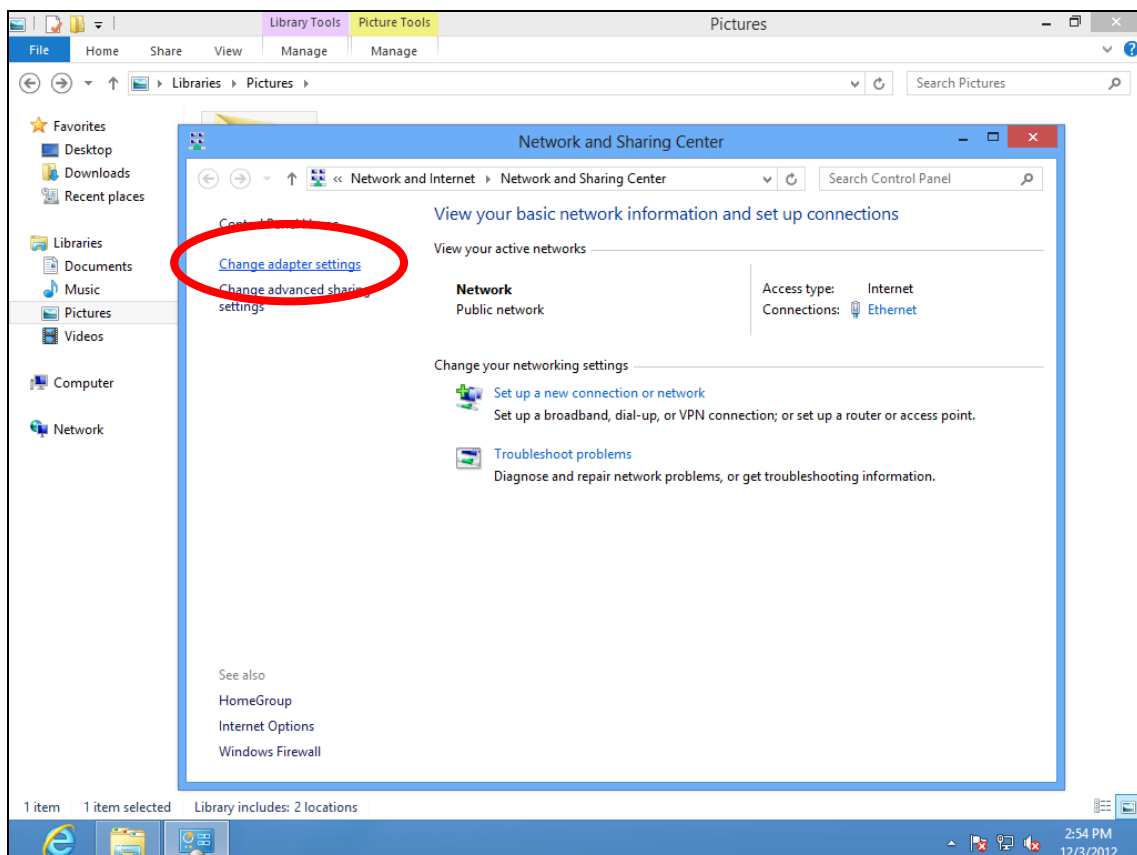

5. Choose your connection and right click, then select "Properties".

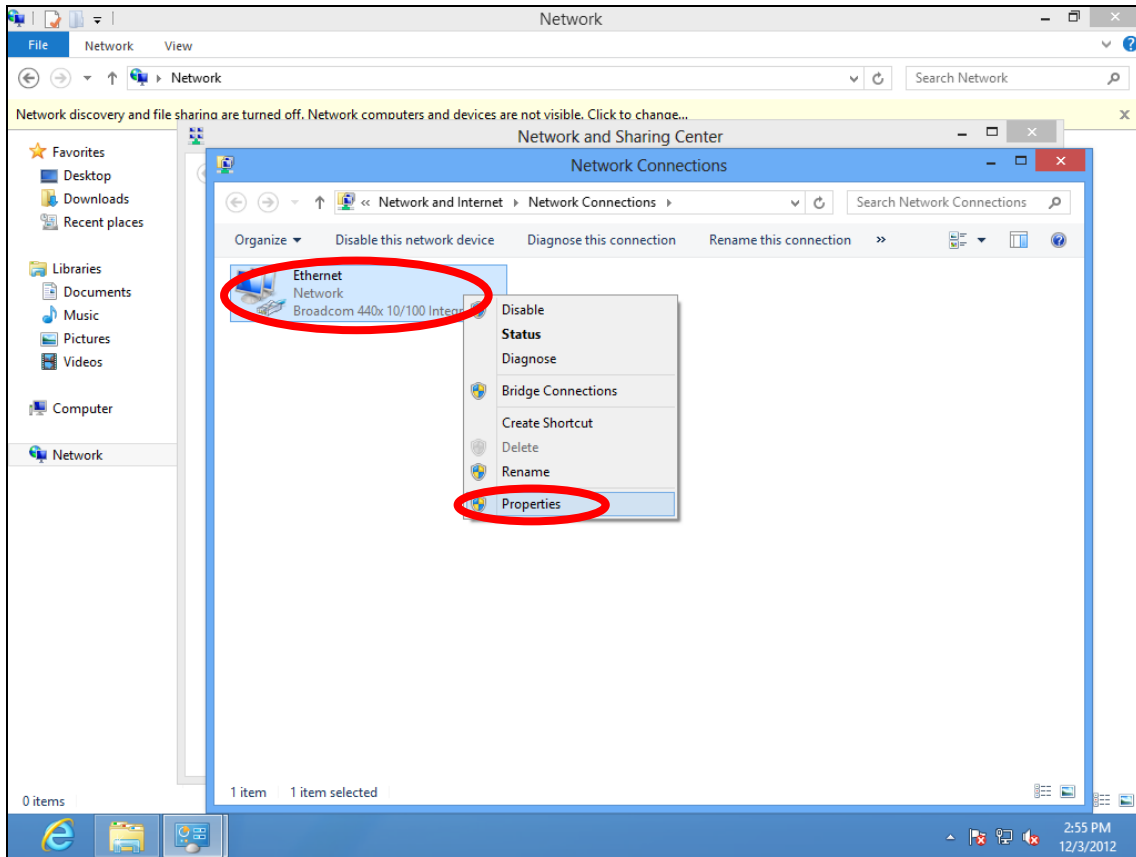

6. Select "Internet Protocol Version 4 (TCP/IPv4)" and then click "Properties".

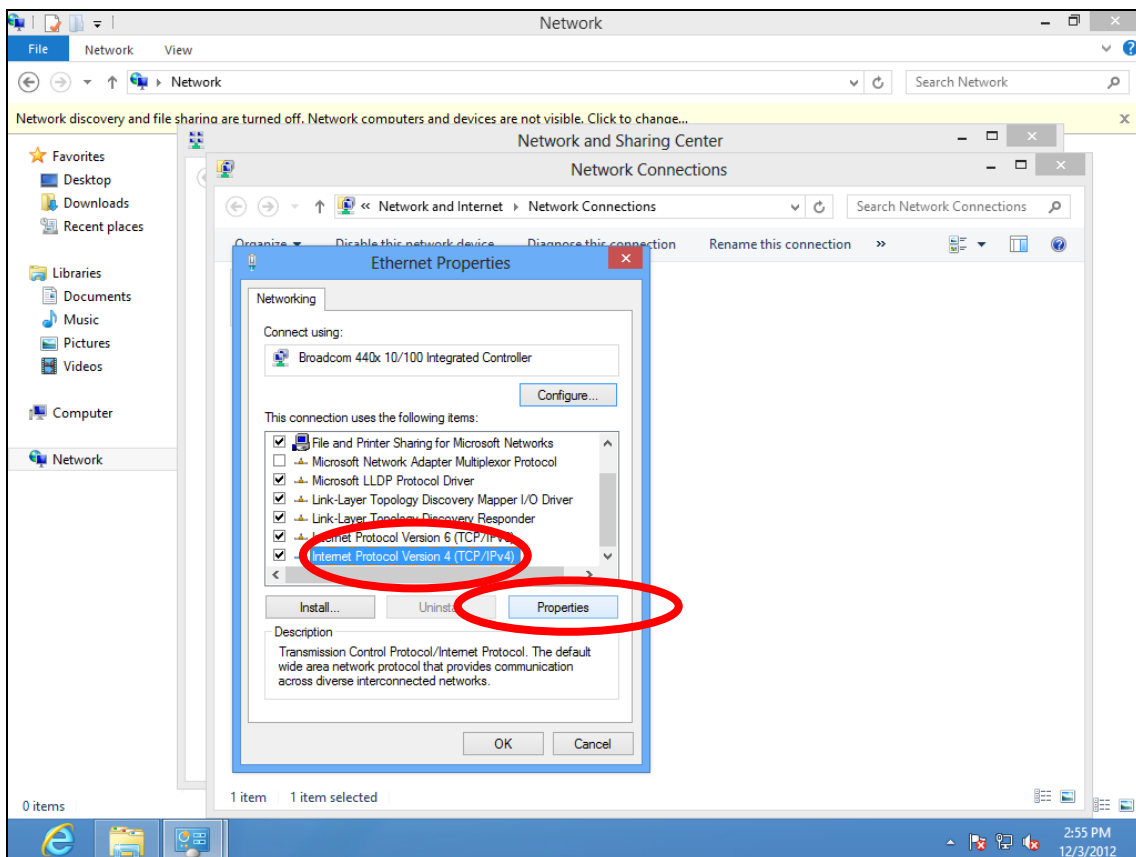

7. Select “Use the following IP address” and “Use the following DNS server addresses”, then input the following values:



***Your existing static IP address will be displayed in the “IP address” field before you replace it. Please make a note of this IP address, subnet mask, default gateway and DNS server addresses.***

**IP address:** 192.168.2.10

**Subnet Mask:** 255.255.255.0

**Preferred DNS Server:** 192.168.2.1

Click ‘OK’ when finished.

## IV-1-2-5. Mac

1. Have your Macintosh computer operate as usual, and click on “System Preferences”

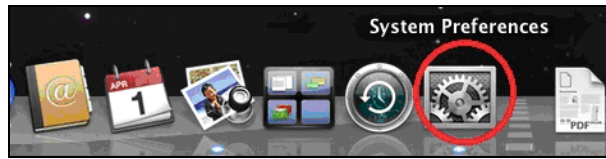

2. In System Preferences, click on “Network”.



3. Click on “Wi-Fi” in the left panel and then click “Advanced” in the lower right corner.

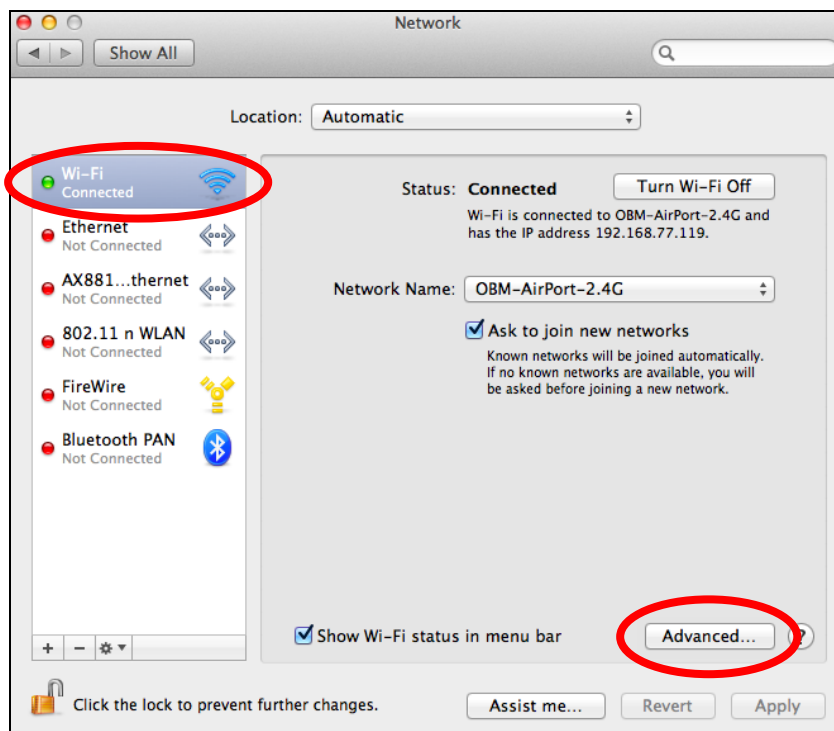

4. Select “TCP/IP” from the top menu and select “Manually” from the drop down menu labeled “Configure IPv4”, then click “OK”.

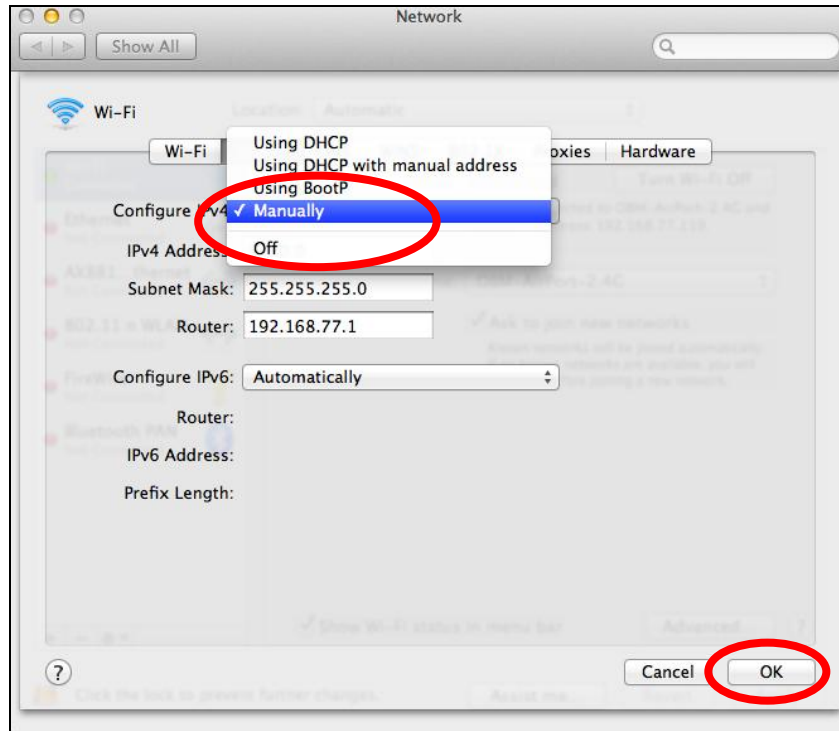

 **Your existing static IP address will be displayed in the “IP address” field before you replace it. Please make a note of this IP address, subnet mask, default gateway and DNS server addresses.**

5. In the “IPv4 Address” and “Subnet Mask” field enter IP address 192.168.2.10 and subnet mask 255.255.255.0. Click on “OK”.

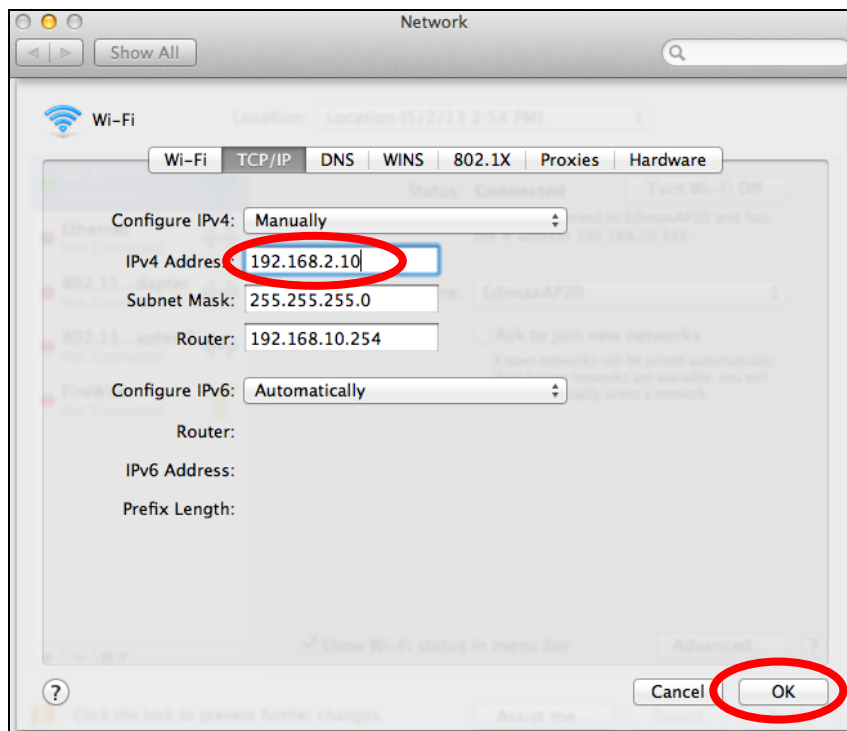

6. Click “Apply” to save the changes.

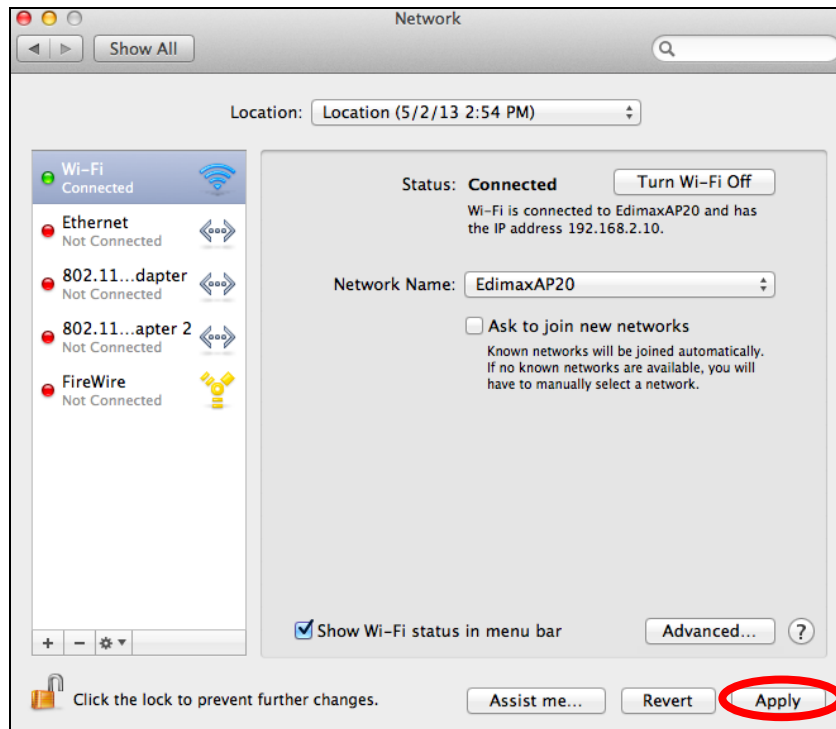

### IV-1-3. How to Find Your Network Security Key

To find your network security key, please follow the instructions appropriate for your operating system.

 ***If you are using Windows XP or earlier, please contact your ISP or router manufacturer to find your network security key.***

#### IV-1-3-1. Windows 7 & Vista

1. Open “Control Panel” and click on “Network and Internet” in the top menu.

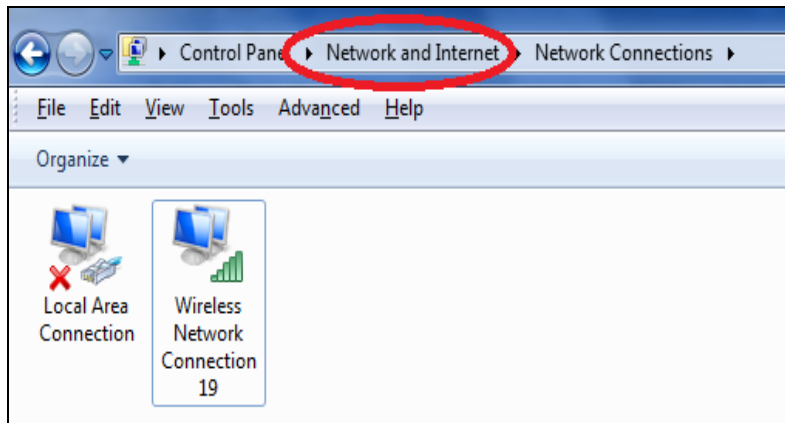

2. Click on “View network status and tasks” which is under the heading “Network and Sharing Center”.

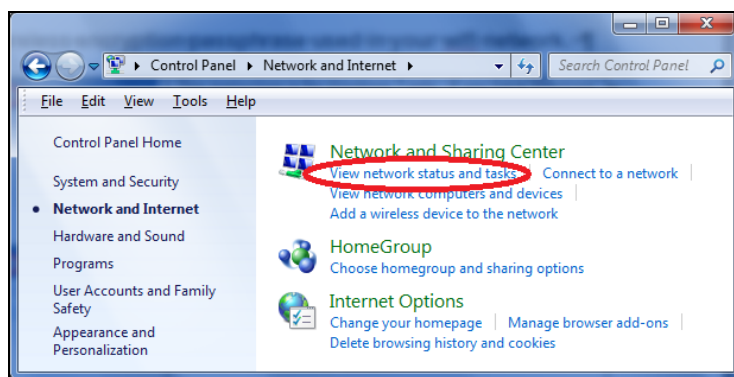

3. Click on “Manage wireless networks” in the left menu.

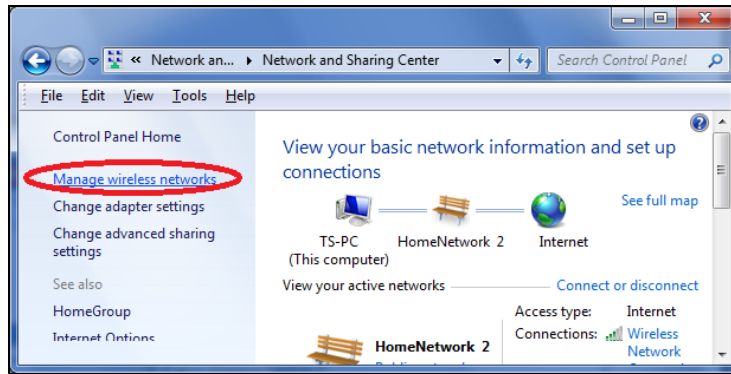

4. You should see the profile of your Wi-Fi network in the list. Right click on your Wi-Fi network and then click on “Properties”.

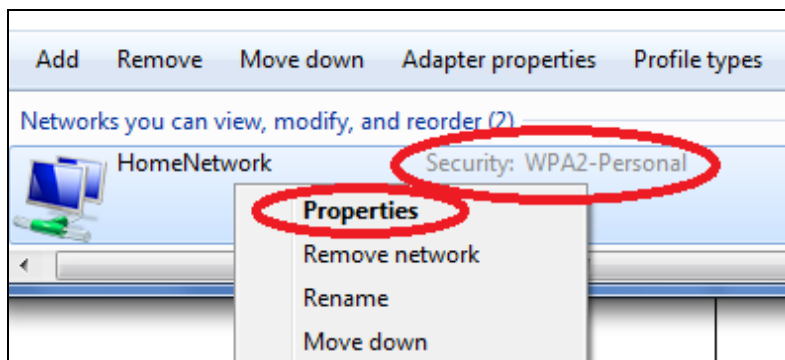

5. Click on the “Security” tab, and then check the box labeled “Show characters”. This will show your network security key. Click the “Cancel” button to close the window.

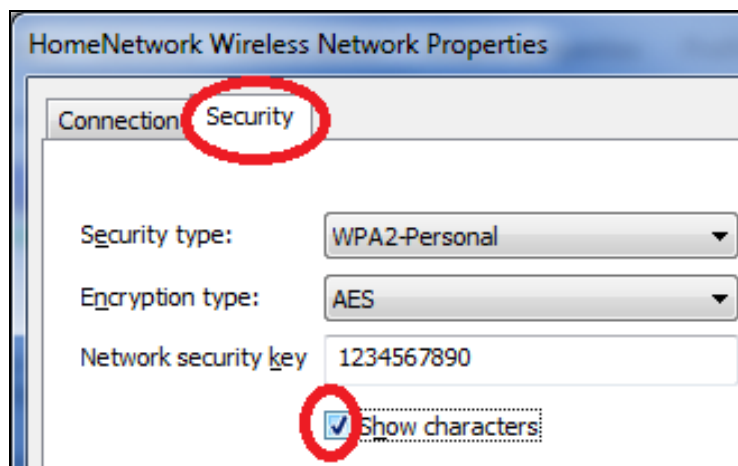



## IV-1-3-2. Mac

1. Open a new Finder window, and select “Applications” from the menu on the left side. Open the folder labeled “Utilities” and then open the application “Keychain Access”.

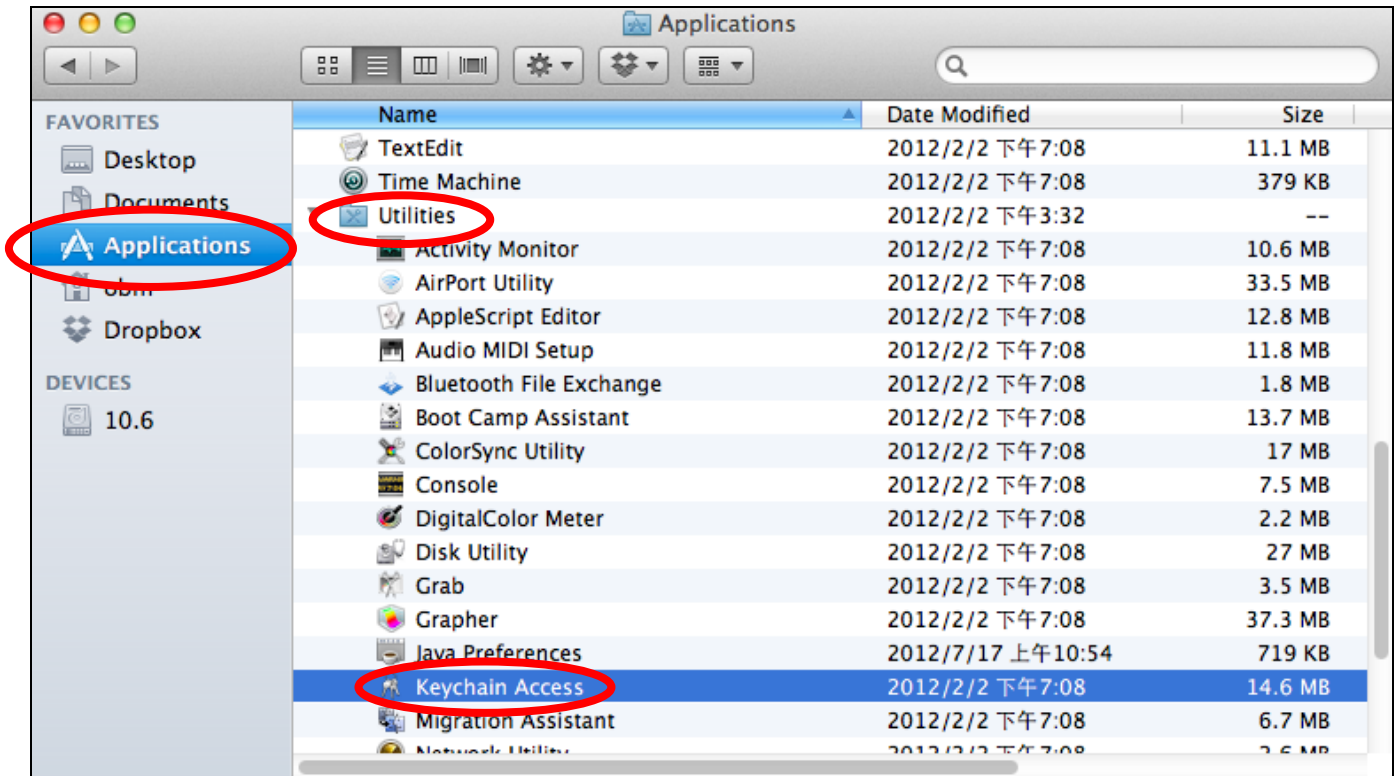

2. Select “Passwords” from the sub-menu labeled “Category” on the left side, as shown below. Then search the list in the main panel for the SSID of your network. In this example, the SSID is “EdimaxWireless” – though your SSID will be unique to your network.

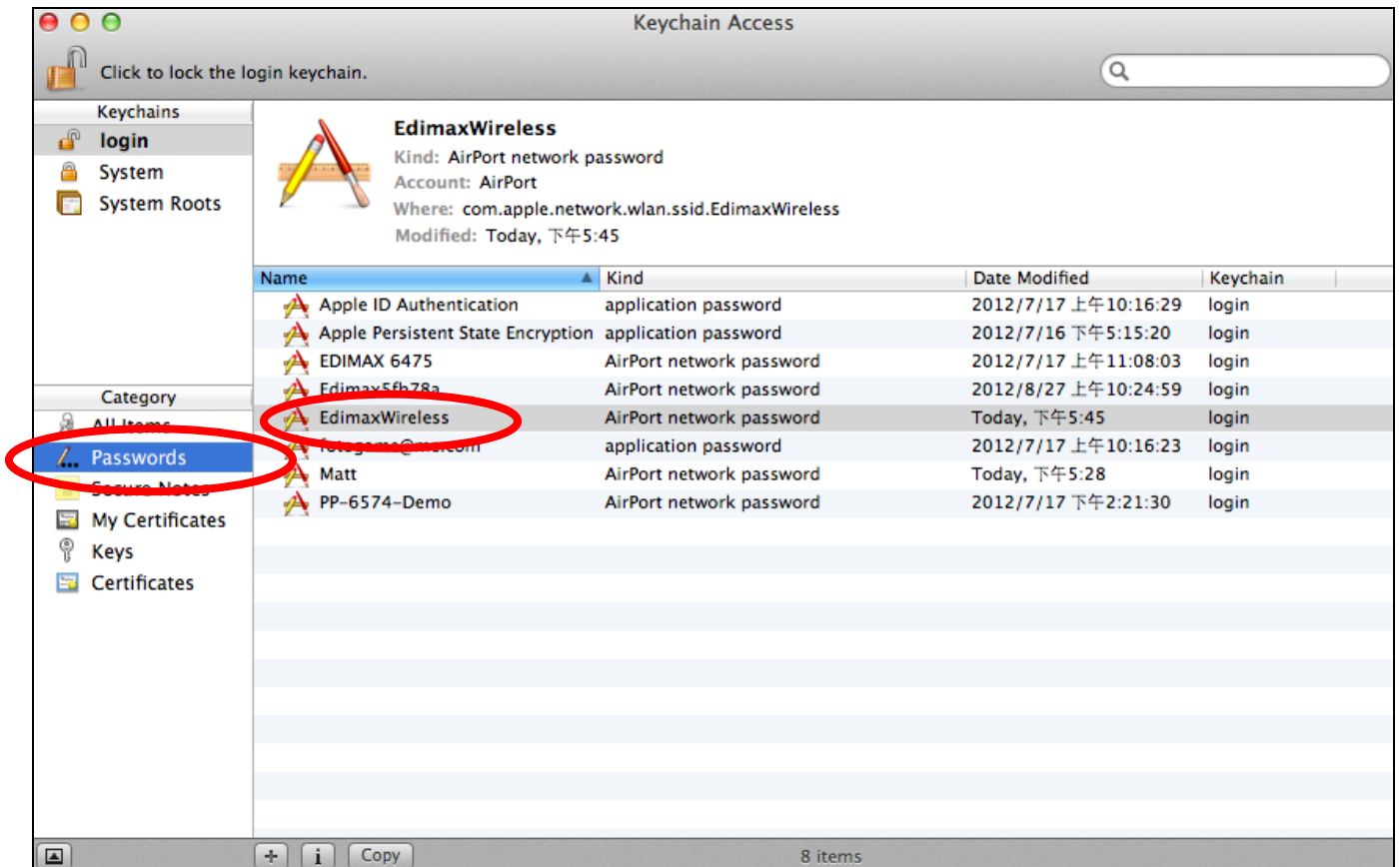

3. Double click the SSID of your network and you will see the following window.

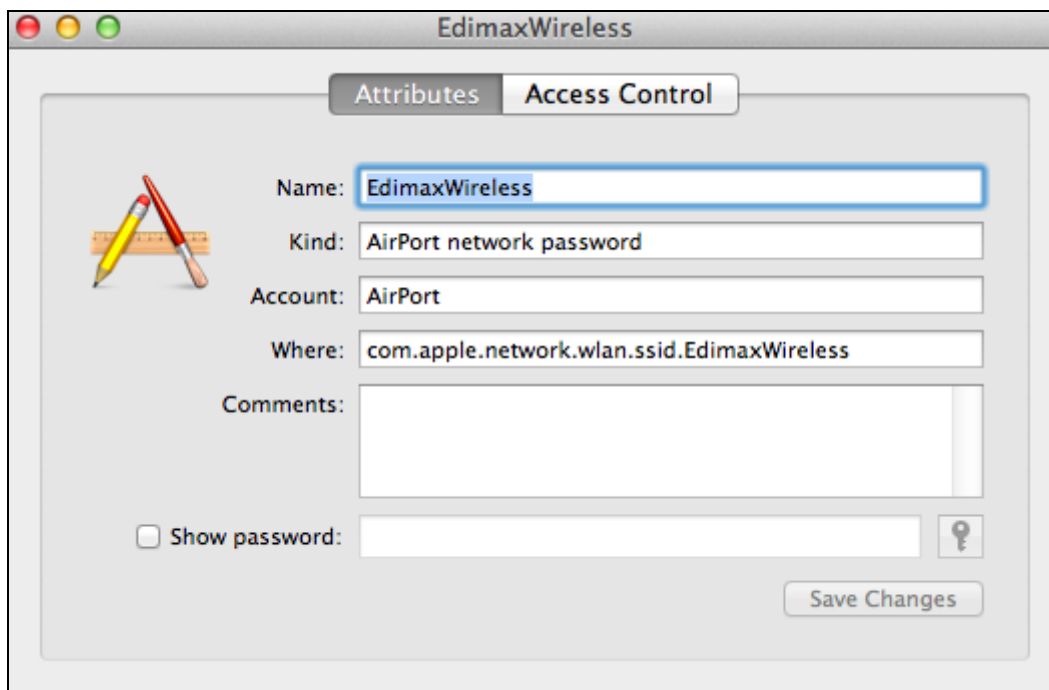

4. Check the box labeled “Show password” and you will be asked to enter your administrative password, which you use to log into your Mac. Enter your password and click “Allow”.

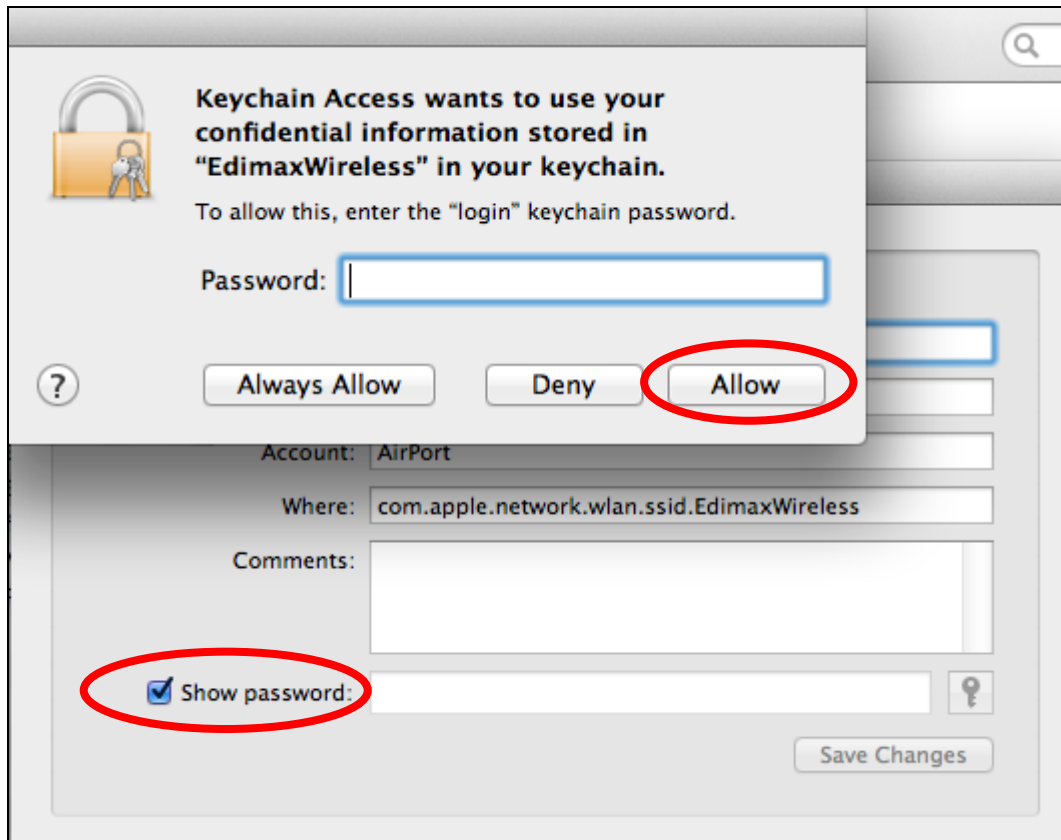

Your network security password will now be displayed in the field next to the box labeled "Show password". In the example below, the network security password is "edimax1234". Please make a note of your network security password.

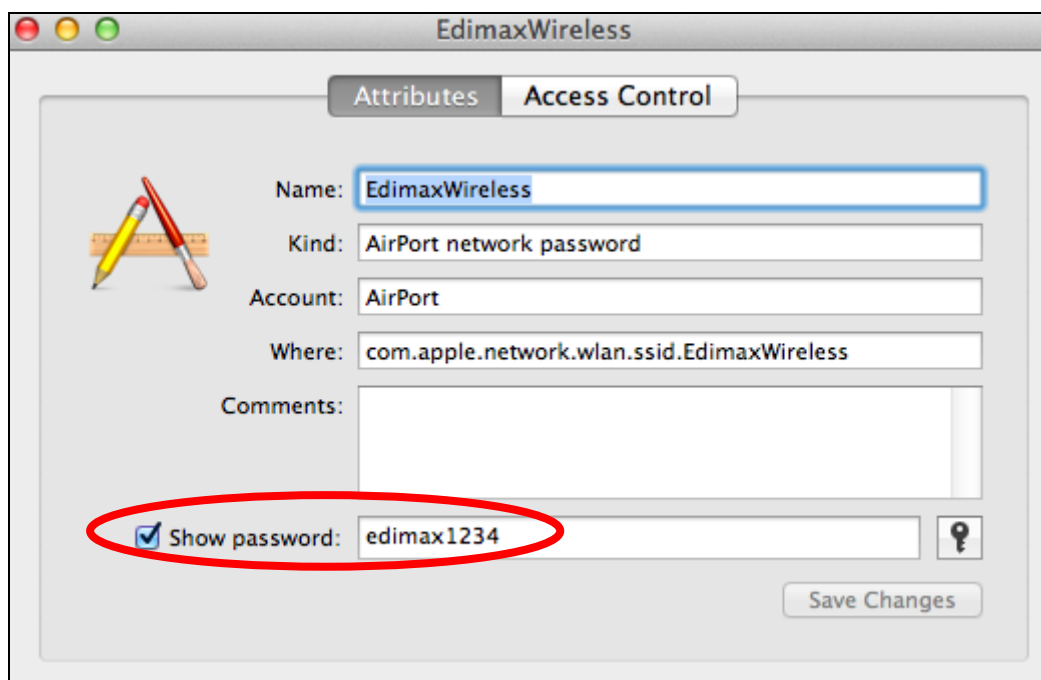

## IV-1-4. How to Find Your Router's IP Address

To find your router's IP address, please follow the instructions appropriate for your operating system.

### IV-1-4-1. Windows XP, Vista & 7

1. Go to "Start", select "Run" and type "cmd", then press Enter or click "OK".

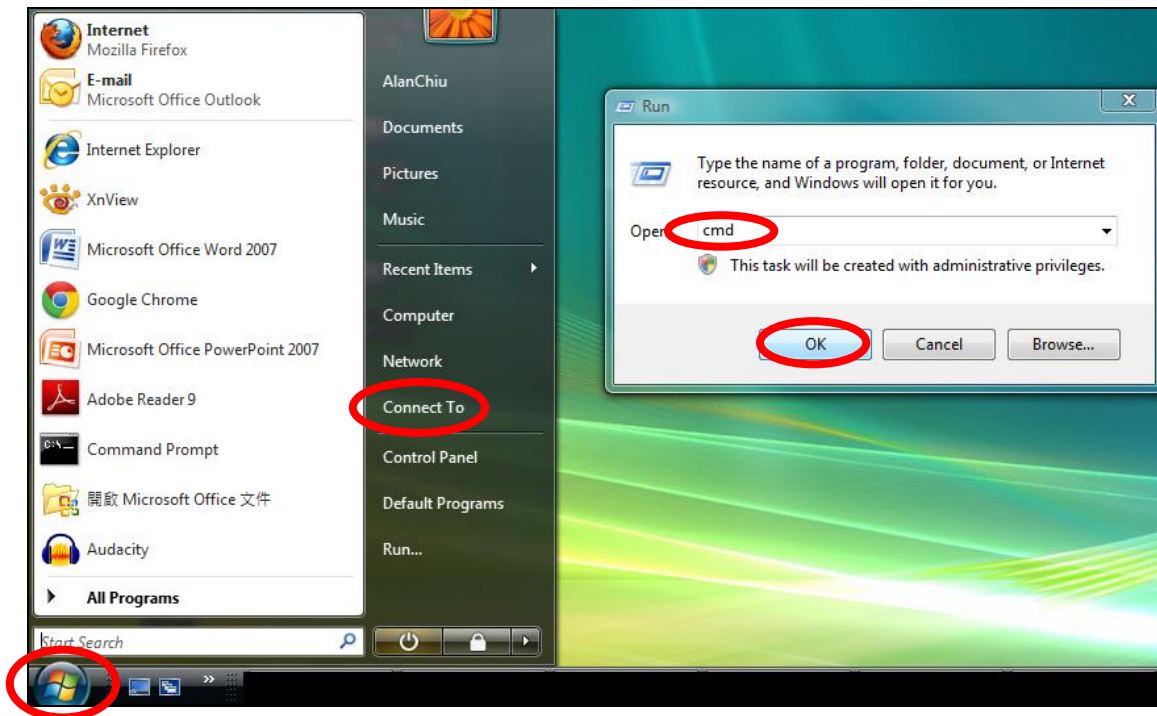

2. A new window will open, type "ipconfig" and press Enter.

```
Administrator: C:\Windows\system32\cmd.exe
Microsoft Windows [Version 6.0.6002]
Copyright (c) 2006 Microsoft Corporation. All rights reserved.

C:\Users\AlanChiu>ipconfig
```

3. Your router's IP address will be displayed next to "Default Gateway".

```
Administrator: C:\Windows\system32\cmd.exe
Ethernet adapter 區域連線:

    Connection-specific DNS Suffix . . . :
    Link-local IPv6 Address . . . . . : fe80::4cdc:3e90:ba56:1722%9
    IPv4 Address. . . . . : 192.168.10.14
    Subnet Mask . . . . . : 255.255.255.0
    Default Gateway . . . . . : fe80::1867:2a1b:e9c2:e57b%9
                                192.168.10.254

Wireless LAN adapter 無線網路連線:

    Media State . . . . . : Media disconnected
    Connection-specific DNS Suffix . . : edimax.com

Tunnel adapter 區域連線* 6:

    Media State . . . . . : Media disconnected
    Connection-specific DNS Suffix . . :

Tunnel adapter 區域連線* 7:

    Media State . . . . . : Media disconnected
    Connection-specific DNS Suffix . . :

C:\Users\AlanChiu>
```

## IV-1-4-2. Windows 8

1. From the Windows 8 Start screen, move your cursor to the top right corner of the screen to display the Charms bar.



2. Click "Search" and enter "cmd" into the search bar. Click the "Command Prompt" app which be displayed on the left side.

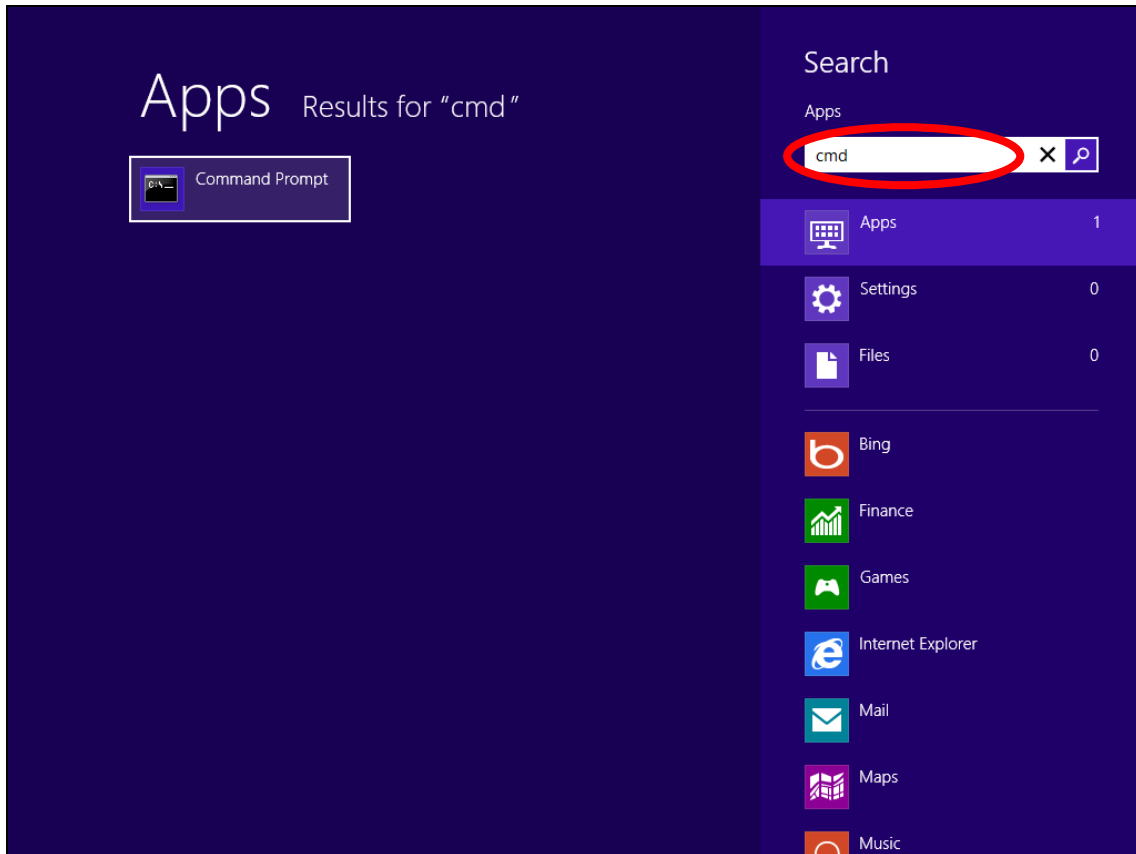

**3.** A new window will open, type “ipconfig” and press Enter.

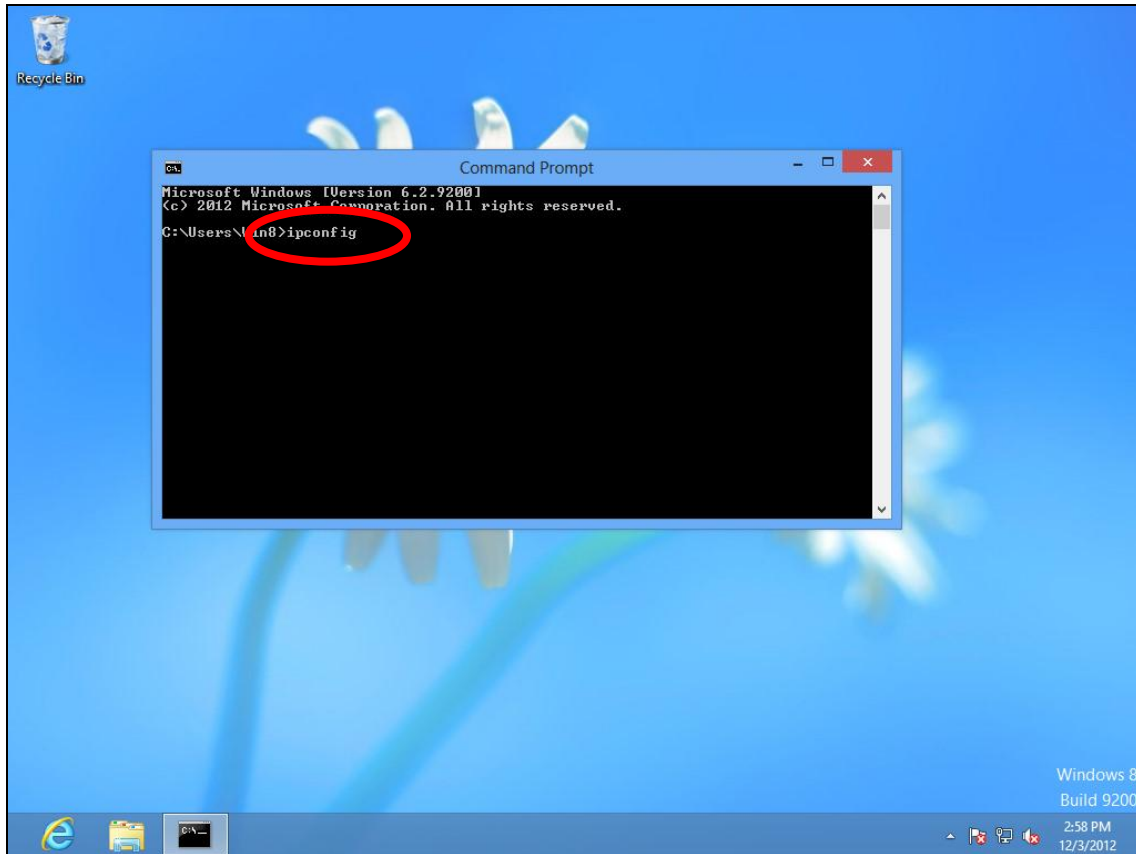

#### 4. Your router's IP address will be displayed next to "Default Gateway".

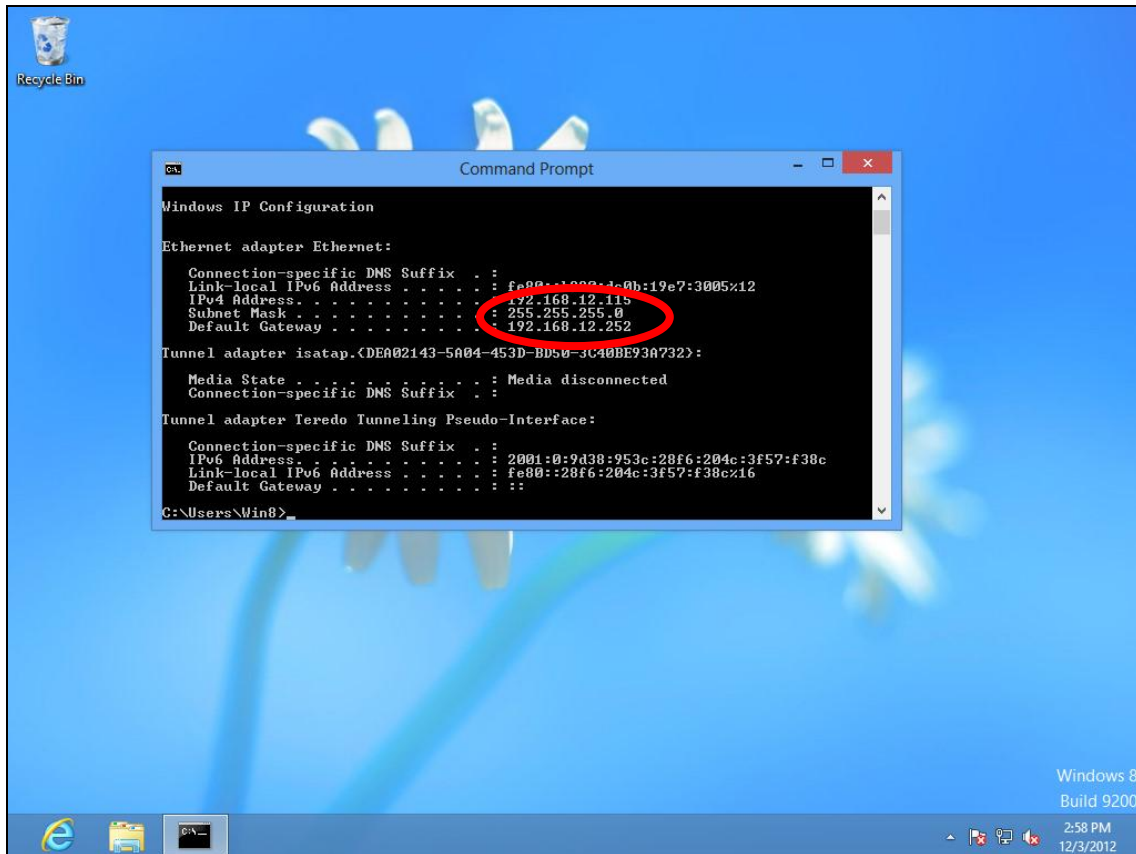



### IV-1-4-3. Mac

1. Launch “System Preferences” and click on “Network”.
2. If you are using an Ethernet cable to connect to your network, your router’s IP address will be displayed next to “Router”.

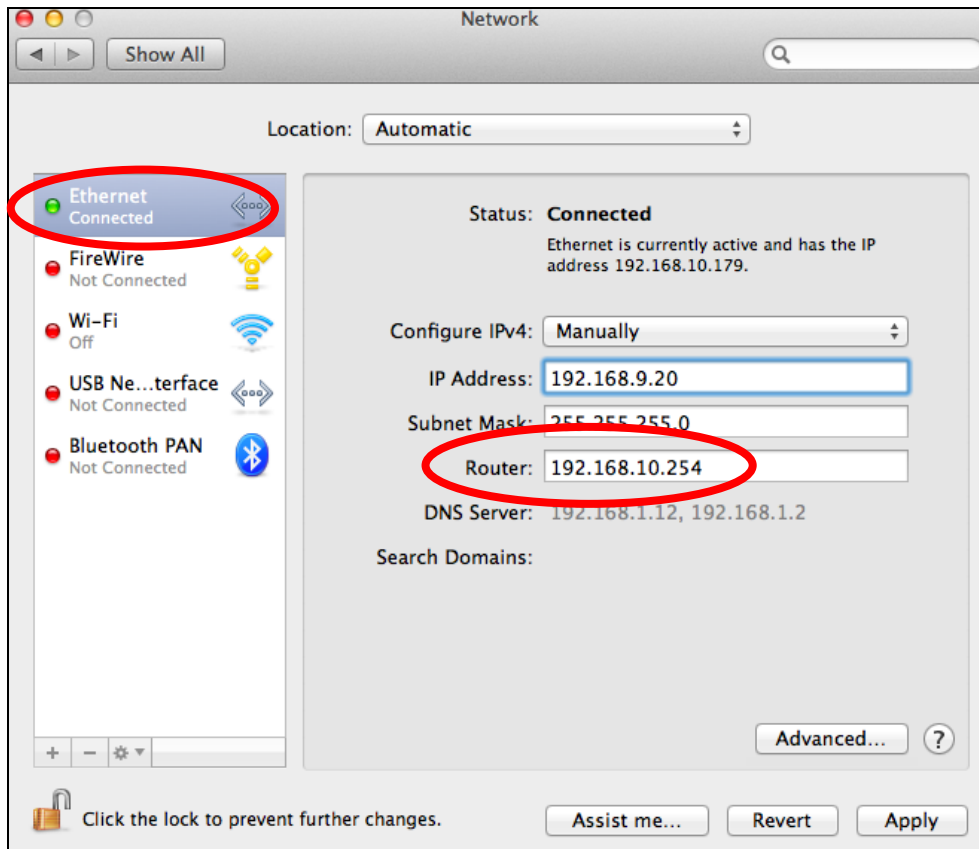

3. If you are using Wi-Fi, click “Wi-Fi” in the left panel, and then “Advanced” in the bottom right corner.

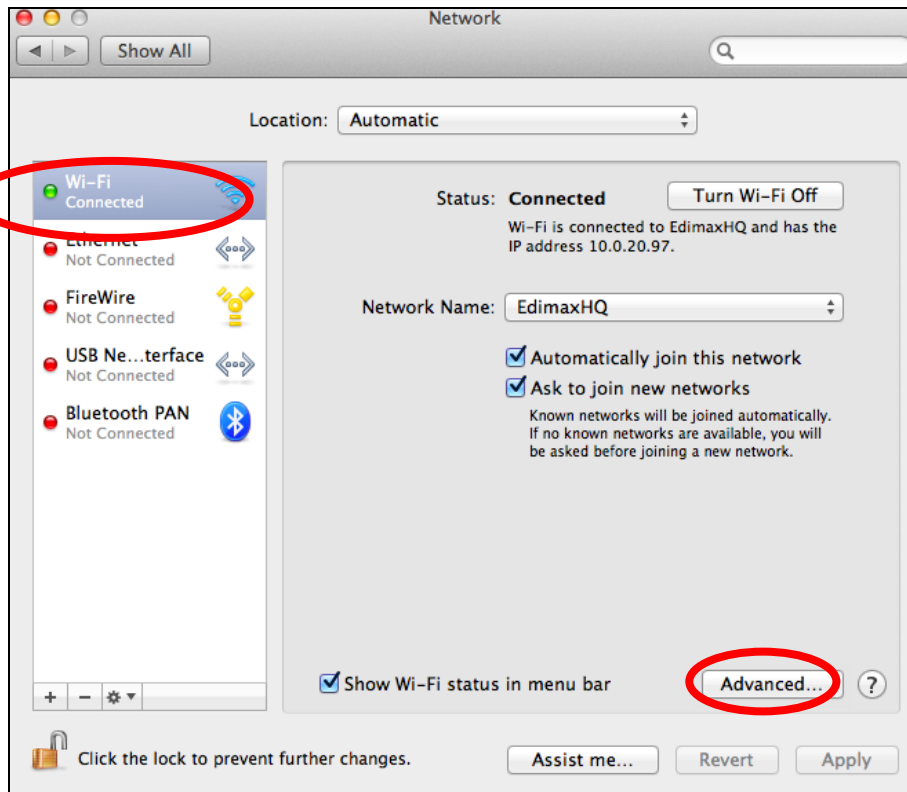

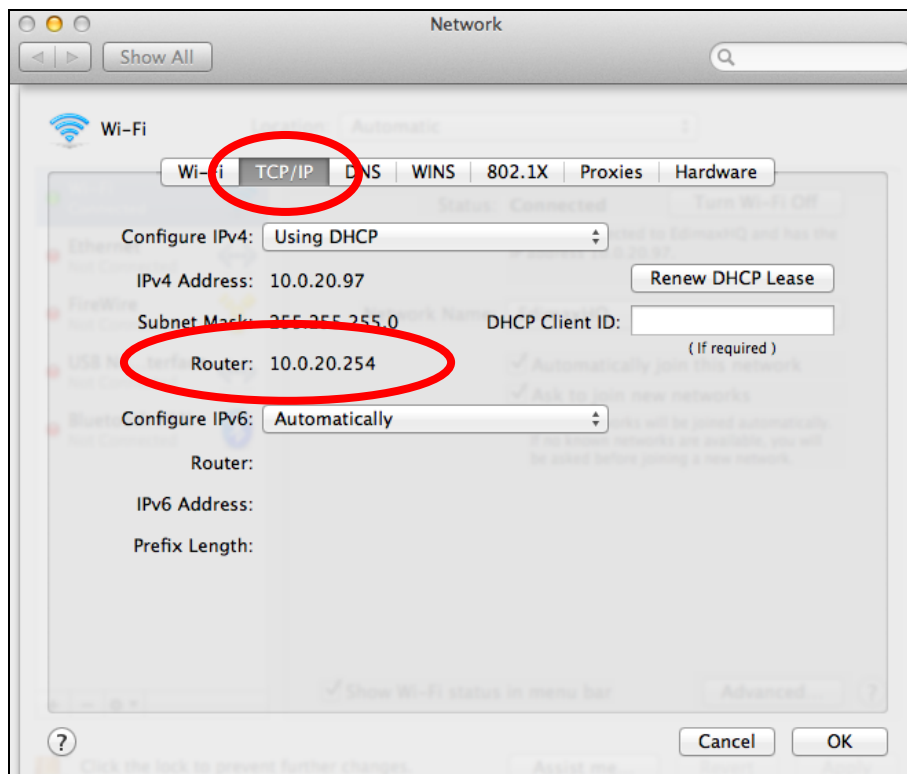

4. Click the “TCP/IP” tab and your router’s IP address will be displayed next to “Router”.



## IV-2. Connecting to a Wi-Fi network

For help connecting to your device's **Edimax.Setup** SSID for initial setup, or to connect to your device's new Wi-Fi network (SSID) after setup is complete, follow the guide below:

 ***Below is an example of how to connect using Windows Vista – the process may vary slightly for other versions of Windows.***

1. Click the network icon (, , or ) in the system tray and select **“Connect to a network”**.

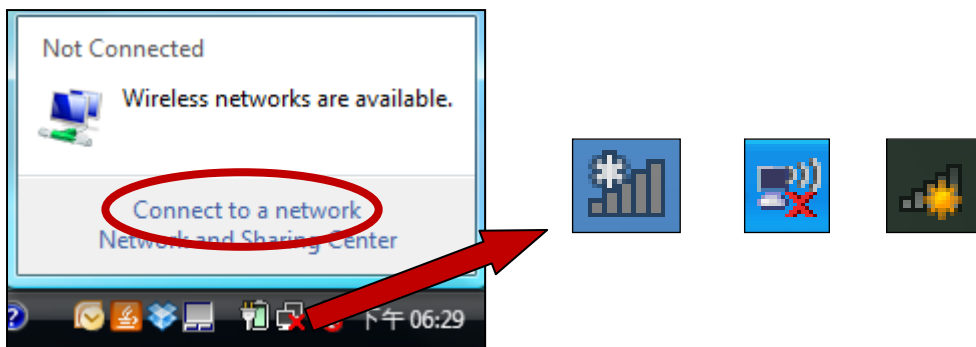

2. Search for the SSID of your BR-6428nS V3/BR-6228nS V3 and then click **“Connect”**. If you set a password for your network, you will then be prompted to enter it.

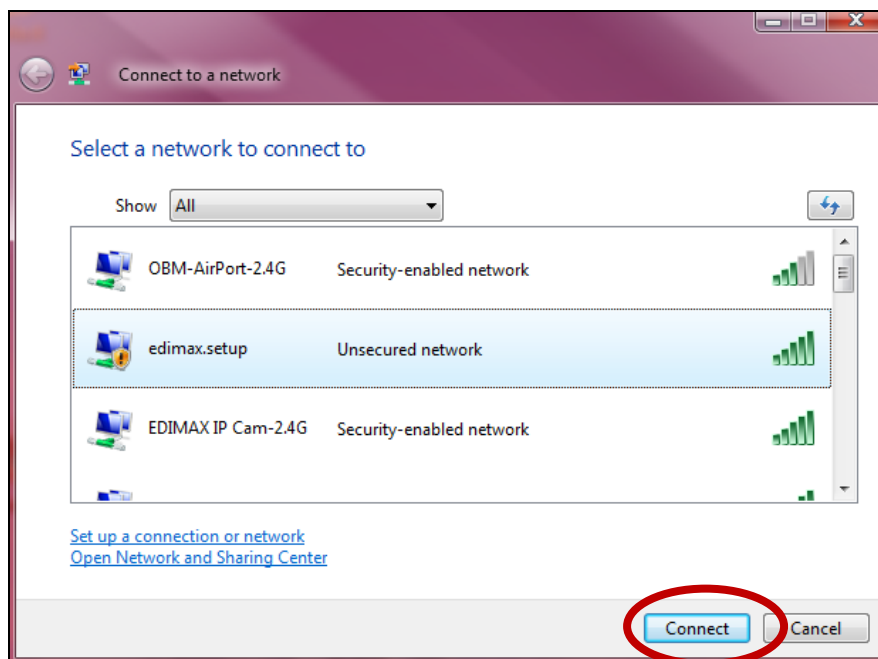

- 3.** After correctly entering your password, you will be successfully connected to the BR-6428nS V3/BR-6228nS V3's wireless network.

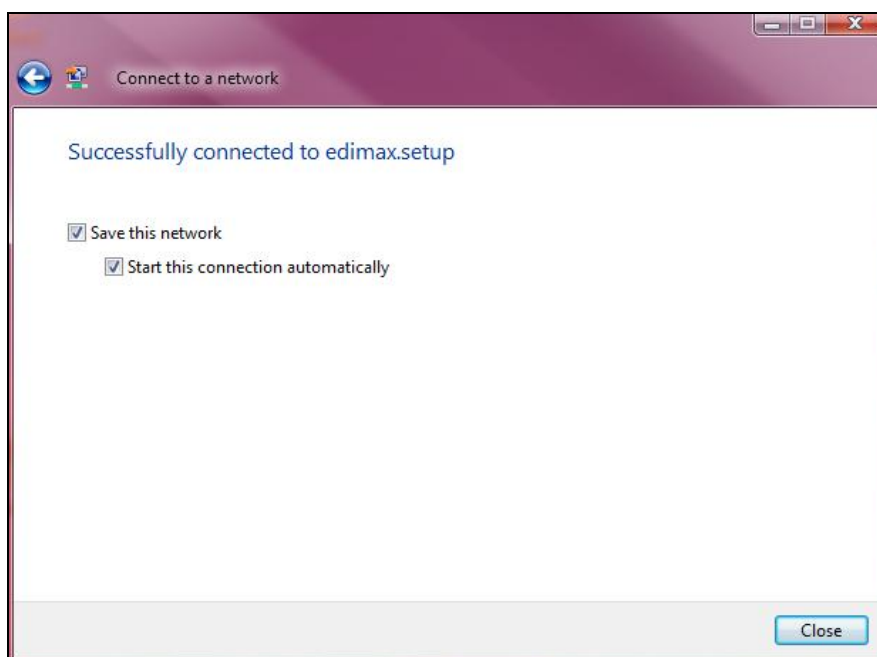

### IV-3. Troubleshooting

If you are experiencing problems with your BR-6428nS V3/BR-6228nS V3, please check below before contacting your dealer of purchase for help.

 ***If you are experiencing problems immediately after a firmware upgrade, please contact your dealer of purchase for help.***

#### 1. In range extender mode, how do I connect to a network which has a hidden SSID?

- a. During iQ Setup select “Setup extender manually” as shown below. Manually enter the SSID of the hidden network, an SSID for your device and the encryption information for the hidden network.

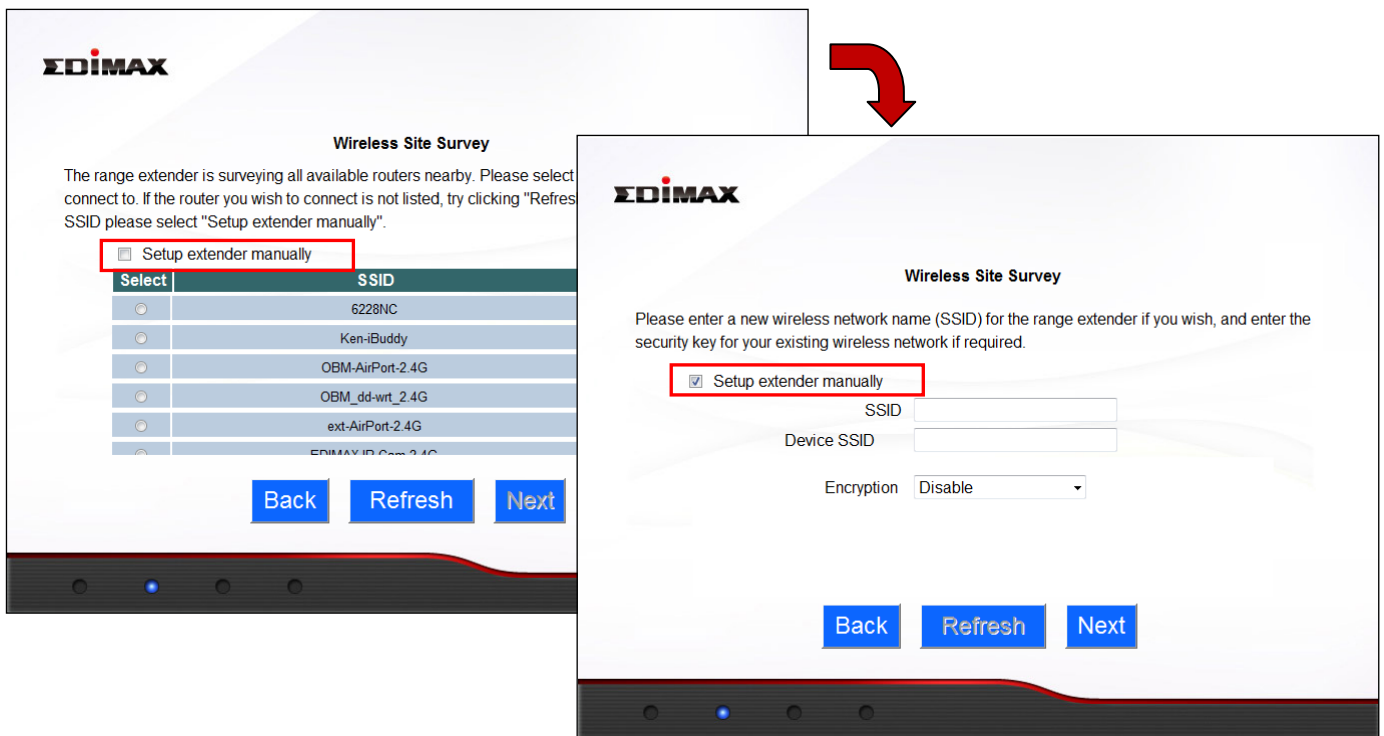

<b>SSID</b>	Enter the SSID (network name) of your existing, hidden network.
<b>Device SSID</b>	Enter an SSID for the BR-6428nS V3/BR-6228nS V3 or leave it blank to use a default which consists of your existing router’s SSID (above) + "_2EX".
<b>Encryption</b>	Enter the encryption information for your existing, hidden network.

## 2. I can't access the Internet.

- a. Ensure that all cables are connected properly. Try a different Ethernet cable.
- b. Switch your BR-6428nS V3/BR-6228nS V3 and network device off and back on again. Check the LED status of the BR-6428nS V3/BR-6228nS V3.
- c. Check if you can access the web based configuration interface. If not, please ensure your computer is set to use a dynamic IP address.
- d. Login to the web based configuration interface and go to **Internet > WAN Setup** and check that the connection type is correct. If you are unsure which internet connection type you have, please contact your Internet Service Provider (ISP).
- e. Connect your computer directly to your modem and check if you can access the internet. If you can't, please contact your Internet service provider for assistance.

## 3. I can't open the browser based configuration interface.

- a. Please ensure your computer is set to use a dynamic IP address. Refer to the user manual for guidance if you are unsure how to do this.
- b. Ensure you enter the correct password. The password is case-sensitive.

## 4. How do I reset my device to factory default settings?

- a. To reset the device back to its factory default settings, press and hold the WPS/Reset button for over 10 seconds, until the power LED begins to flash. Please wait a few minutes for the product to restart. When the device restarts, all settings will be reset. Default settings are displayed on the product label on the back of the device, as shown below:



<b>Router Login</b>	Enter this URL in a web browser to run iQ Setup or configure advanced settings. You must be connected to the device by Wi-Fi or Ethernet cable.
<b>Username/Password</b>	This is the default username and password to access the browser based configuration interface when you go to the “Router Login” URL (above).
<b>Wi-Fi Network Name</b>	This is the default Wi-Fi network name for the device. Search for this name (SSID) and connect to it in order to access the “Router Login” URL (above).
<b>MAC</b>	A MAC address is unique to every device and is used for identification within a network. Your device’s unique MAC address is displayed here.
<b>PIN CODE</b>	This is your device’s PIN code for Wi-Fi Protected Setup (WPS).

## 5. I forgot my password.

- a. Reset the router to its factory default settings and use the default username **admin** and default password **1234**. Default settings are displayed on the product label on the back of the device, as shown above.

## 6. My BR-6428nS V3/BR-6228nS V3 has a weak wireless signal in range extender mode.

- a. Weak signals are usually caused by interference from other devices or obstacles blocking the BR-6428nS V3/BR-6228nS V3’s wireless signal:
- b. Keep the device away from other radio devices such as microwaves or wireless telephones.
- c. Do not put the device in the corner of a room or under/nearby metal.
- d. Ensure there are as few obstacles as possible between the BR-6428nS V3/BR-6228nS V3 and your wireless network device.

***In range extender mode***, the BR-6428nS V3/BR-6228nS V3’S weak wireless signal may be in turn caused by a weak signal from your existing router. It’s important to choose a good location for the BR-6428nS V3/BR-6228nS V3 *in relation to your existing wireless router*. The best location is roughly in the middle between your existing wireless router and the area you would like to be covered by the BR-6428nS V3/BR-6228nS V3. If you are too far away from your existing router, then it is difficult for the BR-6428nS V3/BR-6228nS V3 to receive a wireless signal.

## 7. Do the WAN and LAN ports work the same when the device is in different modes?

No, the WAN and LAN ports have slightly different functions depending on the operating mode of the device.

- a. In **Wi-Fi router** mode, the **WAN port** is for a direct connection to your xDSL modem. The **LAN ports** are for wired network clients.
- b. In **access point** mode, the **WAN port** is not functional. Connect your existing router to the device's **LAN port**, and the other **LAN ports** can connect wired network clients.
- c. In **range extender** mode, the **WAN port** is not functional and the **LAN ports** are for wired network clients. Do not connect your existing router to the device's **WAN** or **LAN ports**, as this can cause the device to malfunction.

## 8. My network is configured to use static IP addresses. How can I assign a static IP address to my BR-6428nS V3/BR-6228nS V3?

- a. You can modify the device's IP address using the browser based configuration interface. Please refer to [III-3-4. LAN](#).



## IV-4. Glossary

**Default Gateway (Wireless bridge):** Every non-access point IP device needs to configure a default gateway's IP address. When the device sends out an IP packet, if the destination is not on the same network, the device has to send the packet to its default gateway, which will then send it out towards the destination.

**DHCP:** Dynamic Host Configuration Protocol. This protocol automatically gives every computer on your home network an IP address.

**DNS Server IP Address:** DNS stands for Domain Name System, which allows Internet servers to have a domain name (such as `www.Broadbandaccesspoint.com`) and one or more IP addresses (such as `192.34.45.8`). A DNS server keeps a database of Internet servers and their respective domain names and IP addresses, so that when a domain name is requested (as in typing "`Broadbandaccesspoint.com`" into your Internet browser), the user is sent to the proper IP address. The DNS server IP address used by the computers on your home network is the location of the DNS server your ISP has assigned to you.

**DSL Modem:** DSL stands for Digital Subscriber Line. A DSL modem uses your existing phone lines to transmit data at high speeds.

**Ethernet:** A standard for computer networks. Ethernet networks are connected by special cables and hubs, and move data around at up to 10/100 million bits per second (Mbps).

**IP Address and Network (Subnet) Mask:** IP stands for Internet Protocol. An IP address consists of a series of four numbers separated by periods, that identifies a single, unique Internet computer host in an IP network. Example: `192.168.2.1`. It consists of 2 portions: the IP network address, and the host identifier.

The IP address is a 32-bit binary pattern, which can be represented as four cascaded decimal numbers separated by ".": `aaa.aaa.aaa.aaa`, where each "aaa" can be anything from 000 to 255, or as four cascaded binary numbers separated by ".": `bbbbbbbb.bbbbbbbb.bbbbbbbb.bbbbbbbb`, where each "b" can either be 0 or 1.

A network mask is also a 32-bit binary pattern, and consists of consecutive leading 1's followed by consecutive trailing 0's, such as 11111111.11111111.11111111.00000000. Therefore sometimes a network mask can also be described simply as "x" number of leading 1's. When both are represented side by side in their binary forms, all bits in the IP address that correspond to 1's in the network mask become part of the IP network address, and the remaining bits correspond to the host ID.

For example, if the IP address for a device is, in its binary form, 11011001.10110000.10010000.00000111, and if its network mask is, 11111111.11111111.11110000.00000000 It means the device's network address is 11011001.10110000.10010000.00000000, and its host ID is, 00000000.00000000.00000000.00000111. This is a convenient and efficient method for access points to route IP packets to their destination.

**ISP Gateway Address:** (see ISP for definition). The ISP Gateway Address is an IP address for the Internet access point located at the ISP's office.

**ISP:** Internet Service Provider. An ISP is a business that provides connectivity to the Internet for individuals and other businesses or organizations.

**LAN:** Local Area Network. A LAN is a group of computers and devices connected together in a relatively small area (such as a house or an office). Your home network is considered a LAN.

**MAC Address:** MAC stands for Media Access Control. A MAC address is the hardware address of a device connected to a network. The MAC address is a unique identifier for a device with an Ethernet interface. It is comprised of two parts: 3 bytes of data that corresponds to the Manufacturer ID (unique for each manufacturer), plus 3 bytes that are often used as the product's serial number.

**NAT:** Network Address Translation. This process allows all of the computers on your home network to use one IP address. Using the broadband access point's NAT capability, you can access the Internet from any computer on your home network without having to purchase more IP addresses from your ISP.

**Port:** Network Clients (LAN PC) uses port numbers to distinguish one network application/protocol over another. Below is a list of common applications and protocol/port numbers:

Application	Protocol	Port Number
Telnet	TCP	23
FTP	TCP	21
SMTP	TCP	25
POP3	TCP	110
H.323	TCP	1720
SNMP	UCP	161
SNMP Trap	UDP	162
HTTP	TCP	80
PPTP	TCP	1723
PC Anywhere	TCP	5631
PC Anywhere	UDP	5632

**Access point:** A access point is an intelligent network device that forwards packets between different networks based on network layer address information such as IP addresses.

**Subnet Mask:** A subnet mask, which may be a part of the TCP/IP information provided by your ISP, is a set of four numbers (e.g. 255.255.255.0) configured like an IP address. It is used to create IP address numbers used only within a particular network (as opposed to valid IP address numbers recognized by the Internet, which must be assigned by InterNIC).

**TCP/IP, UDP:** Transmission Control Protocol/Internet Protocol (TCP/IP) and Unreliable Datagram Protocol (UDP). TCP/IP is the standard protocol for data transmission over the Internet. Both TCP and UDP are transport layer protocol. TCP performs proper error detection and error recovery, and thus is reliable. UDP on the other hand is not reliable. They both run on top of the IP (Internet Protocol), a network layer protocol.

**WAN:** Wide Area Network. A network that connects computers located in geographically separate areas (e.g. different buildings, cities, countries). The Internet is a wide area network.

**Web-based management Graphical User Interface (GUI):** Many devices support a graphical user interface that is based on the web browser. This means the user can use the familiar Netscape or Microsoft Internet Explorer to Control/configure or monitor the device being managed.

## COPYRIGHT

Copyright © Edimax Technology Co., Ltd. all rights reserved. No part of this publication may be reproduced, transmitted, transcribed, stored in a retrieval system, or translated into any language or computer language, in any form or by any means, electronic, mechanical, magnetic, optical, chemical, manual or otherwise, without the prior written permission from Edimax Technology Co., Ltd.

Edimax Technology Co., Ltd. makes no representations or warranties, either expressed or implied, with respect to the contents hereof and specifically disclaims any warranties, merchantability, or fitness for any particular purpose. Any software described in this manual is sold or licensed as is. Should the programs prove defective following their purchase, the buyer (and not this company, its distributor, or its dealer) assumes the entire cost of all necessary servicing, repair, and any incidental or consequential damages resulting from any defect in the software. Edimax Technology Co., Ltd. reserves the right to revise this publication and to make changes from time to time in the contents hereof without the obligation to notify any person of such revision or changes.

The product you have purchased and the setup screen may appear slightly different from those shown in this QIG. The software and specifications are subject to change without notice. Please visit our website [www.edimax.com](http://www.edimax.com) for updates. All brand and product names mentioned in this manual are trademarks and/or registered trademarks of their respective holders.

## **Federal Communication Commission Interference Statement**

This equipment has been tested and found to comply with the limits for a Class B digital device, pursuant to Part 15 of FCC Rules. These limits are designed to provide reasonable protection against harmful interference in a residential installation. This equipment generates, uses, and can radiate radio frequency energy and, if not installed and used in accordance with the instructions, may cause harmful interference to radio communications. However, there is no guarantee that interference will not occur in a particular installation. If this equipment does cause harmful interference to radio or television reception, which can be determined by turning the equipment off and on, the user is encouraged to try to correct the interference by one or more of the following measures:

1. Reorient or relocate the receiving antenna.
2. Increase the separation between the equipment and receiver.
3. Connect the equipment into an outlet on a circuit different from that to which the receiver is connected.
4. Consult the dealer or an experienced radio technician for help.

### **FCC Caution**

This device and its antenna must not be co-located or operating in conjunction with any other antenna or transmitter. This device complies with Part 15 of the FCC Rules. Operation is subject to the following two conditions: (1) this device may not cause harmful interference, and (2) this device must accept any interference received, including interference that may cause undesired operation. Any changes or modifications not expressly approved by the party responsible for compliance could void the authority to operate equipment.

### **Federal Communications Commission (FCC) Radiation Exposure Statement**

This equipment complies with FCC radiation exposure set forth for an uncontrolled environment. In order to avoid the possibility of exceeding the FCC radio frequency exposure limits, human proximity to the antenna shall not be less than 2.5cm (1 inch) during normal operation.

### **Federal Communications Commission (FCC) RF Exposure Requirements**

This EUT is compliance with SAR for general population/uncontrolled exposure limits in ANSI/IEEE C95.1-1999 and had been tested in accordance with the measurement methods and procedures specified in OET Bulletin 65 Supplement C. The equipment version marketed in US is restricted to usage of the channels 1-11 only.

## **R&TTE Compliance Statement**

This equipment complies with all the requirements of DIRECTIVE 1999/5/EC OF THE EUROPEAN PARLIAMENT AND THE COUNCIL of March 9, 1999 on radio equipment and telecommunication terminal equipment and the mutual recognition of their conformity (R&TTE). The R&TTE Directive repeals and replaces in the directive 98/13/EEC (Telecommunications Terminal Equipment and Satellite Earth Station Equipment) As of April 8, 2000.

### **Safety**

This equipment is designed with the utmost care for the safety of those who install and use it. However, special attention must be paid to the dangers of electric shock and static electricity when working with electrical equipment. All guidelines of this and of the computer manufacture must therefore be allowed at all times to ensure the safe use of the equipment.

### **EU Countries Intended for Use**

The ETSI version of this device is intended for home and office use in Austria, Belgium, Bulgaria, Cyprus, Czech, Denmark, Estonia, Finland, France, Germany, Greece, Hungary, Ireland, Italy, Latvia, Lithuania, Luxembourg, Malta, Netherlands, Poland, Portugal, Romania, Slovakia, Slovenia, Spain, Sweden, Turkey, and United Kingdom. The ETSI version of this device is also authorized for use in EFTA member states: Iceland, Liechtenstein, Norway, and Switzerland.

### **EU Countries Not Intended for Use**

None

## EU Declaration of Conformity

- English:** This equipment is in compliance with the essential requirements and other relevant provisions of Directive 1999/5/EC, 2009/125/EC.
- Français:** Cet équipement est conforme aux exigences essentielles et autres dispositions de la directive 1999/5/CE, 2009/125/CE.
- Čeština:** Toto zařízení je v souladu se základními požadavky a ostatními příslušnými ustanoveními směrnic 1999/5/ES, 2009/125/ES.
- Polski:** Urządzenie jest zgodne z ogólnymi wymaganiami oraz szczególnymi warunkami określonymi Dyrektywą UE 1999/5/EC, 2009/125/EC.
- Română:** Acest echipament este în conformitate cu cerințele esențiale și alte prevederi relevante ale Directivei 1999/5/CE, 2009/125/CE.
- Русский:** Это оборудование соответствует основным требованиям и положениям Директивы 1999/5/EC, 2009/125/EC.
- Magyar:** Ez a berendezés megfelel az alapvető követelményeknek és más vonatkozó irányelveknek (1999/5/EK, 2009/125/EC).
- Türkçe:** Bu cihaz 1999/5/EC, 2009/125/EC direktifleri zorunlu istekler ve diğer hükümlerle ile uyumludur.
- Українська:** Обладнання відповідає вимогам і умовам директиви 1999/5/EC, 2009/125/EC.
- Slovenčina:** Toto zariadenie spĺňa základné požiadavky a ďalšie príslušné ustanovenia smerníc 1999/5/ES, 2009/125/ES.
- Deutsch:** Dieses Gerät erfüllt die Voraussetzungen gemäß den Richtlinien 1999/5/EC, 2009/125/EC.
- Español:** El presente equipo cumple los requisitos esenciales de la Directiva 1999/5/EC, 2009/125/EC.
- Italiano:** Questo apparecchio è conforme ai requisiti essenziali e alle altre disposizioni applicabili della Direttiva 1999/5/CE, 2009/125/CE.
- Nederlands:** Dit apparaat voldoet aan de essentiële eisen en andere van toepassing zijnde bepalingen van richtlijn 1999/5/EC, 2009/125/EC.
- Português:** Este equipamento cumpre os requisitos essenciais da Directiva 1999/5/EC, 2009/125/EC.
- Norsk:** Dette utstyret er i samsvar med de viktigste kravene og andre relevante regler i Direktiv 1999/5/EC, 2009/125/EC.
- Svenska:** Denna utrustning är i överensstämmelse med de väsentliga kraven och övriga relevanta bestämmelser i direktiv 1999/5/EG, 2009/125/EG.
- Dansk:** Dette udstyr er i overensstemmelse med de væsentligste krav og andre relevante forordninger i direktiv 1999/5/EC, 2009/125/EC.
- Suomi:** Tämä laite täyttää direktiivien 1999/5/EY, 2009/125/EY oleelliset vaatimukset ja muut asiaankuuluvat määräykset.

FOR USE IN 



---

### WEEE Directive & Product Disposal



At the end of its serviceable life, this product should not be treated as household or general waste. It should be handed over to the applicable collection point for the recycling of electrical and electronic equipment, or returned to the supplier for disposal.

## Declaration of Conformity

We, Edimax Technology Co., Ltd., declare under our sole responsibility, that the equipment described below complies with the requirements of the European R&TTE directives.

**Equipment: 5-in-1 N300 Wi-Fi Router, Access Point & Range Extender**

**Model No.: BR-6428nS V3**

**Equipment: 5-in-1 N150 Wi-Fi Router, Access Point & Range Extender**

**Model No.: BR-6228nS V3**

The following European standards for essential requirements have been followed:

AN/NZS CISPR 22: 2009+A1:2010

EN 300 328 V1.8.1 (2012-06)

EN 301 489-1 V1.9.2 (2011-09)

EN 301 489-17 V2.2.1 (2012-09)

EN 55022: 2010+AC:2011 Class B

EN 55024: 2010

IEC 60950-1:2005(2nd)+A1:2009/EN 60950-1:2006+A11:2009+A1:2010+A12:2011+A2:2013

EN 61000-3-2: 2006+A1:2009+A2:2009 Class A

EN 61000-3-3: 2013

IEC 61000-4-2: 2008 / EN 61000-4-2:2009

IEC 61000-4-3: 2006+A1: 2008+A2: 2010 / EN 61000-4-3: 2006+A1: 2008+A2: 2010

IEC 61000-4-4: 2012 / EN 61000-4-4: 2012

IEC 61000-4-5: 2005 / EN 61000-4-5: 2006

IEC 61000-4-6: 2008 / EN 61000-4-6: 2009

IEC 61000-4-11: 2004 / EN 61000-4-11: 2004

Edimax Technology Co., Ltd.  
No. 3, Wu Chuan 3<sup>rd</sup> Road,  
Wu-Ku Industrial Park,  
New Taipei City, Taiwan



Date of Signature: July, 2014

Signature:

A handwritten signature in black ink, appearing to read 'Albert Chang', written over a horizontal line.

Printed Name:

Albert Chang

Title:

Director

Edimax Technology Co., Ltd.



**EDIMAX**  
NETWORKING PEOPLE TOGETHER

The logo is centered on a dark horizontal band. The background of this band is filled with a repeating pattern of light gray icons representing various concepts: a handshake, musical notes, a smiley face, a game controller, a computer monitor, a network of nodes, and a hand holding a leaf. The text 'EDIMAX' is in a large, bold, white sans-serif font, with a small red dot above the 'i'. Below it, the tagline 'NETWORKING PEOPLE TOGETHER' is written in a smaller, white, all-caps sans-serif font. The entire graphic is set against a white background.